

super uno

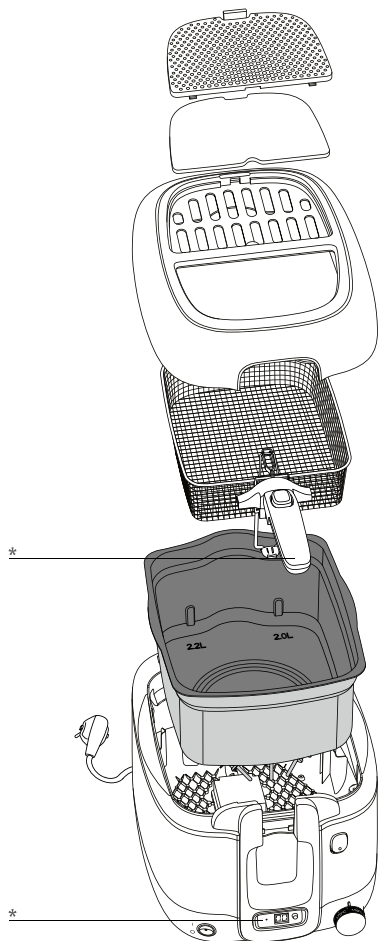

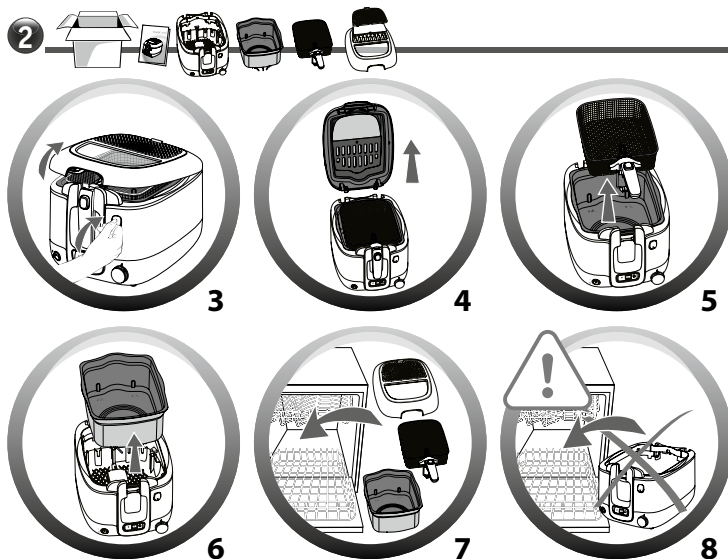

* Selon modèle • Afhankelijk van het model • Je nach Modell • Depending on model • Secondo i modelli • Segun modelo • Consoante o modelo • ανάλογα με το μοντέλο • Modelle göre • Afhængig af model • Beroende på modell • Avhenger av modell • Mallista riippen • Ovisno o modelu • Zavisno od modela • в зависимости от модели • Odvisno od modela • W zależności od typu • Podle modelu • V závislosti od modelu • Modelltöl fúggöen • В зависимости от модели • Залежно від моделі • Ovisno o modelu • Sólitvaltt mudelist • Atbilstoši modelim • Pagal modelį • حسب الموديل • بحسب مدل • afhængig af modellen • beroende på modell • avhengig av modell • mallista riippen • залежно від моделі • үлгіге байланысты • vastavalt mudelitele • atkarībā no modeļa • pagal modelius • zależnie od modelu • у зависимости од модела • glede na model • zavisno od modela • в зависимости от модели • in functie de model • 視乎型號而定 • 모델에 따라 다름 • 根據型號而定 • bergantung pada model

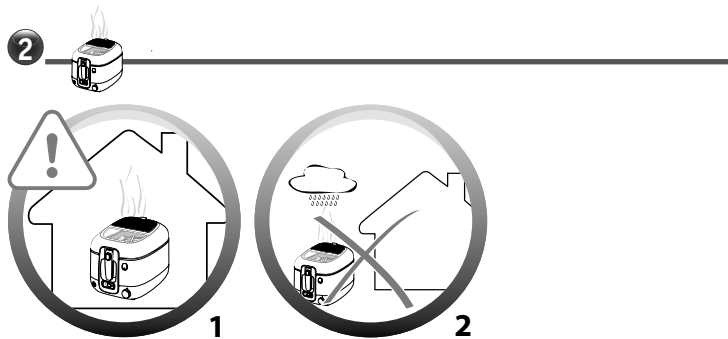

2

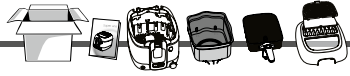

9

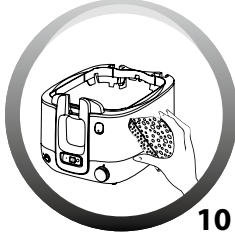

10

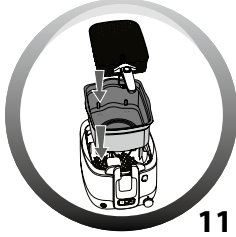

11

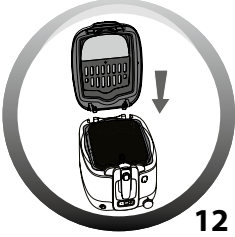

12

3

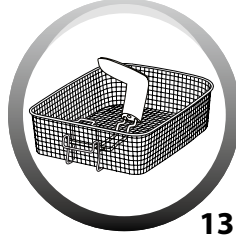

13

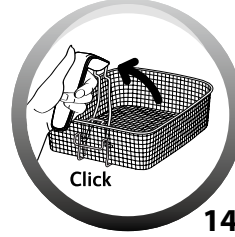

Click

14

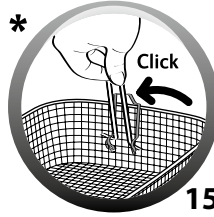

Click

15

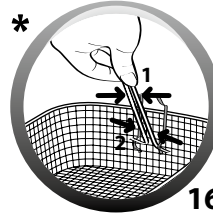

16

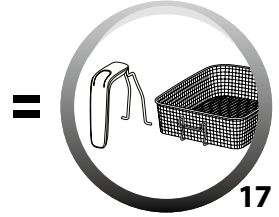

17

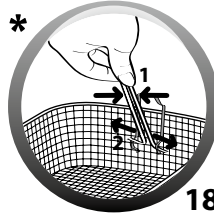

18

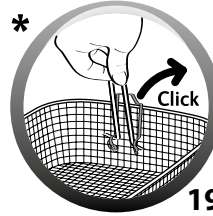

19



20

4



Min. 2 L / Max. 2,2 L

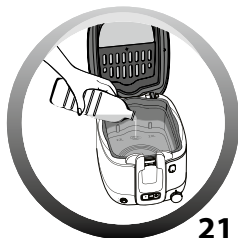

21



22



23

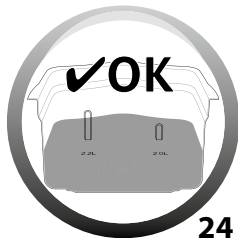

24

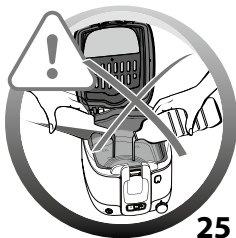

25

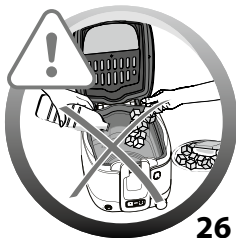

26

5



Min. 1,75 Kg / Max. 2 Kg

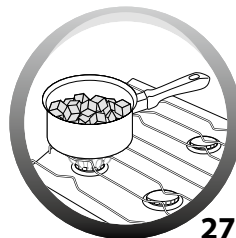

27

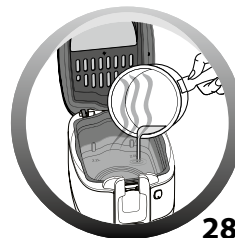

28



29



30

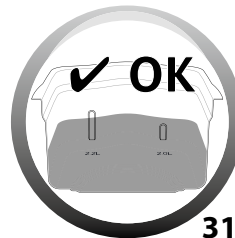

31

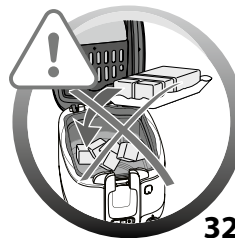

32



33

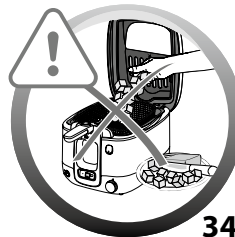

34

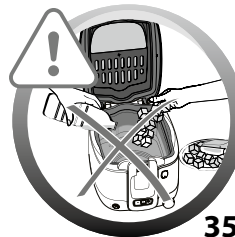

35

6



Max 1,4 Kg

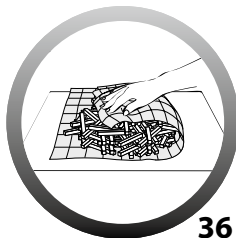

36

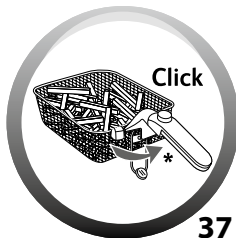

Click

37



38



Max 1 Kg

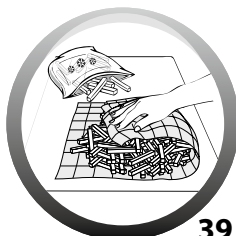

39

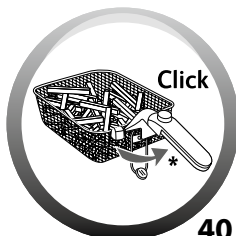

Click

40



41

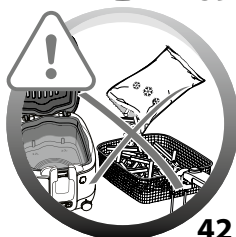

42

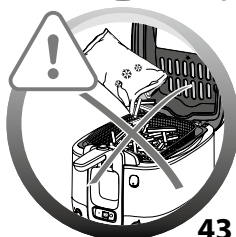

43

8

7

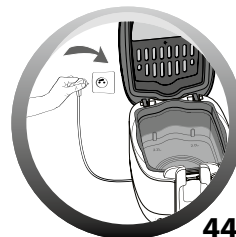

44

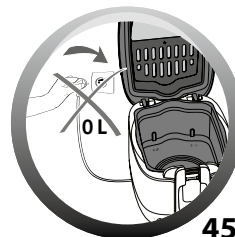

45

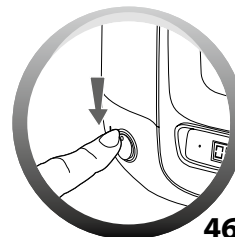

46

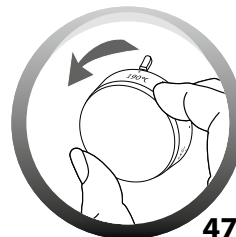

47

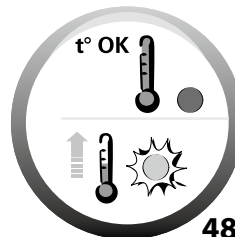

48

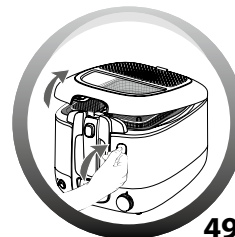

49

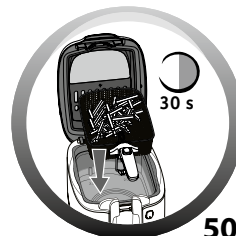

50

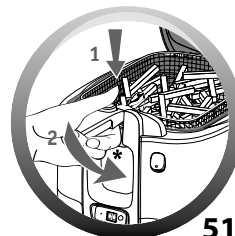

51

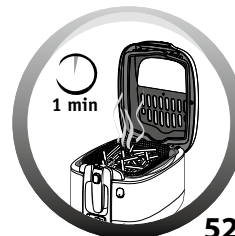

52

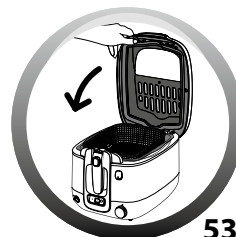

53

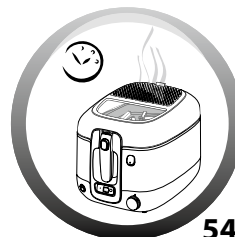

54

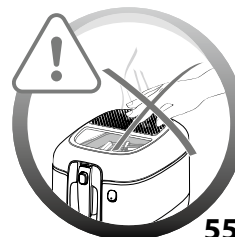

55

9

8



| | Nb | | | |
|--|-----------|--------|----------------------|-----------------------|
| | | 1400 g | 1) 170°C 2) 190°C | 10-12 min 8-10 min |
| | | 1300 g | 190°C | 19-22 min |
| | 5 | | 180°C | 14-16 min |
| | 2 | | 170°C | 4-6 min |
| | 8-10 | | 190°C | 4-5 min |
| | 7 | | 170°C | 2-4 min |
| | 8 | | 170°C | 2-3 min |
| | 6 | | 180°C | 2 x 2 min |
| | Nb | | | |
| | | 1000 g | 190°C | 14-17 min |
| | | 1500 g | 190°C | 9-11 min |
| | | 150 g | 180°C | 4-5 min |
| | 8 | | 180°C | 3-5 min |
| | 11 | | 190°C | 4-5 min |
| | 10 | | 180°C | 2-3 min |
| | 5 | | 180°C | 4-5 min |

9

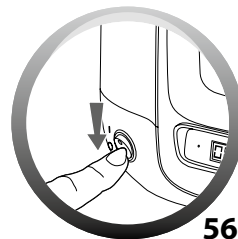

56

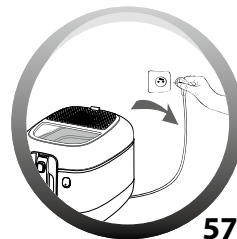

57

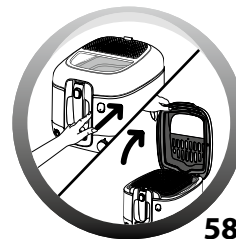

58



59

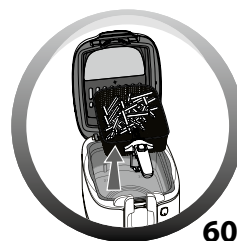

60

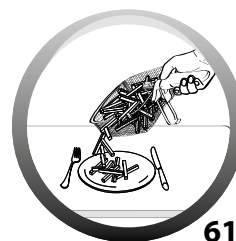

61

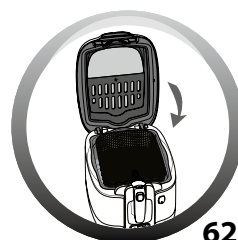

62

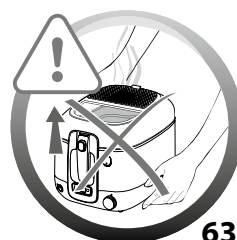

63

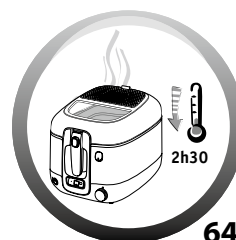

64

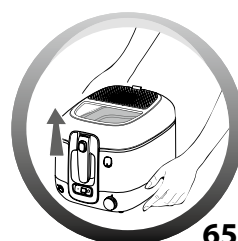

65

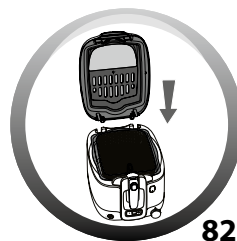
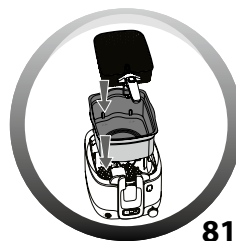
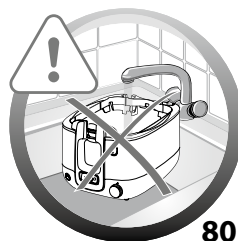
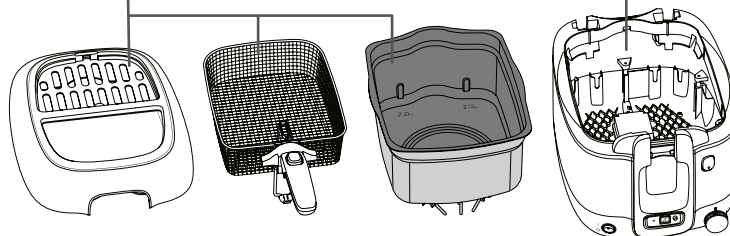
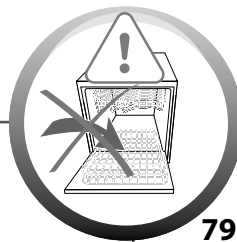
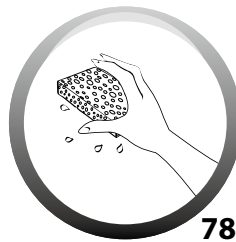
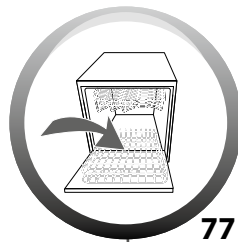
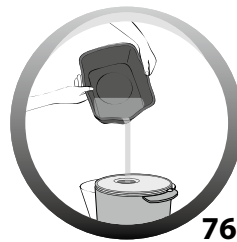
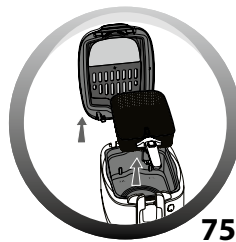
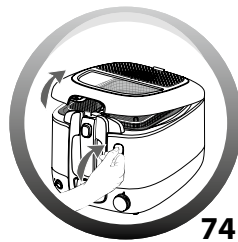
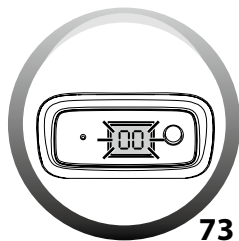
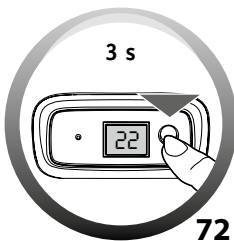
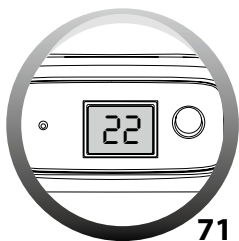
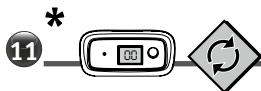
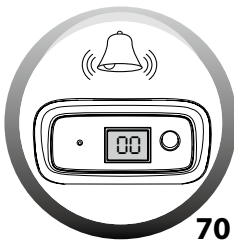
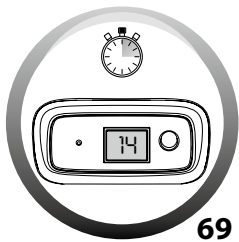
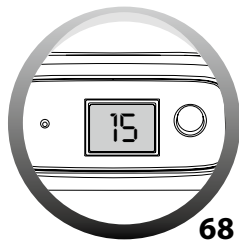
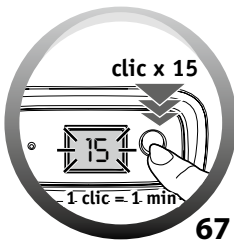
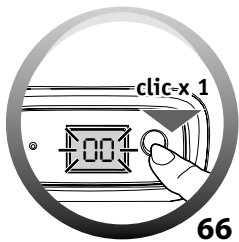

13



12 x
Max

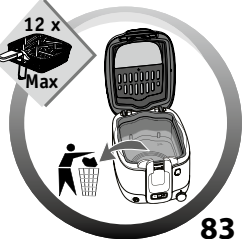

83



84



85

14



80 x
Max

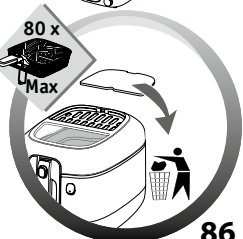

86

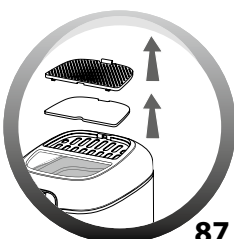

87



88

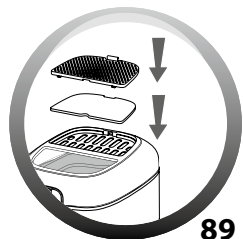

89

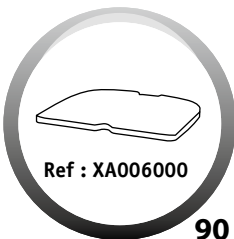

90



91

15

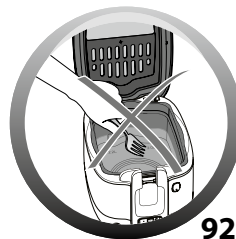

92



93



94

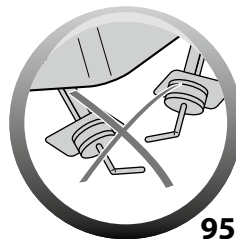

95

