

Register Now
www.delonghi.it/photo



www.delonghi.com



5712570049_02_0120 printed in China

FH2184 FH2394

RAPID CRISP

ELECTRIC CHARACTERISTICS
CARACTÉRISTIQUES ÉLECTRIQUES
CARACTERISTICAS ELECTRICAS:

120V~ 60 Hz 1700 Watts



De'Longhi

EN

page 5

FR

page 12

ES

pág. 19

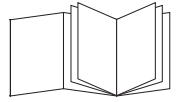

For more recipes:
(free download)



De'Longhi Recipes

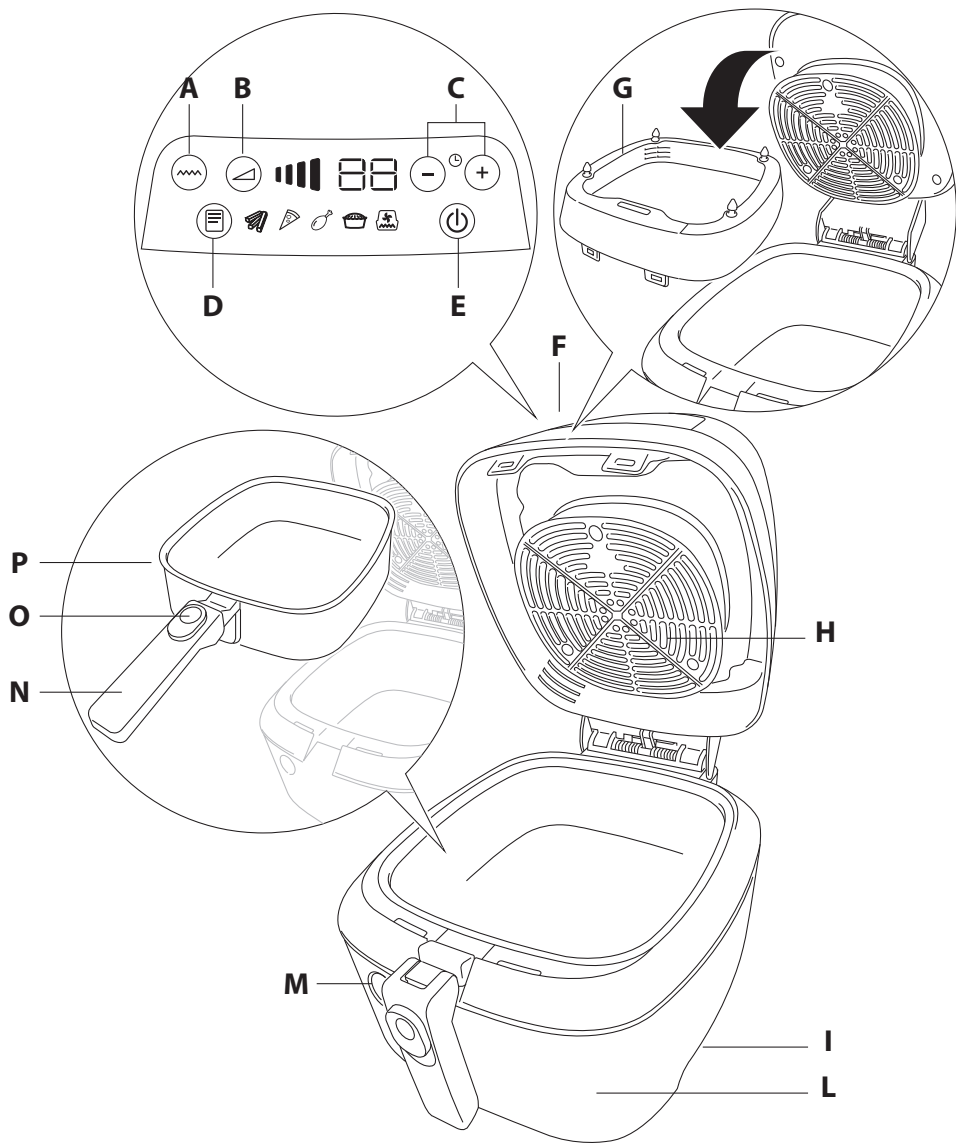

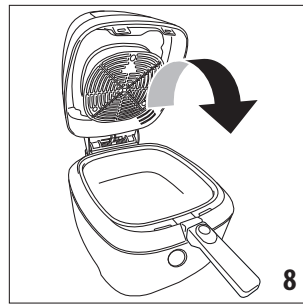
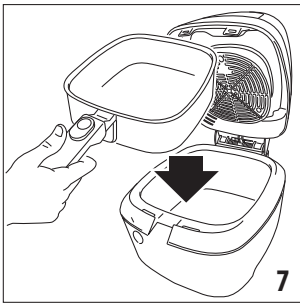
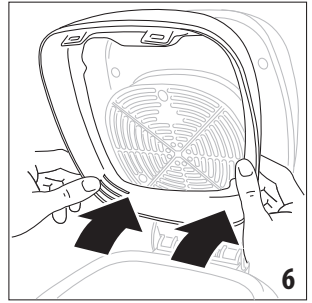
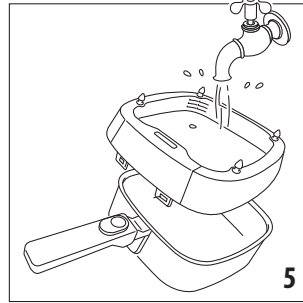
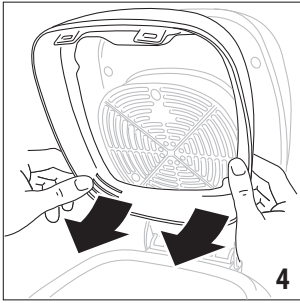
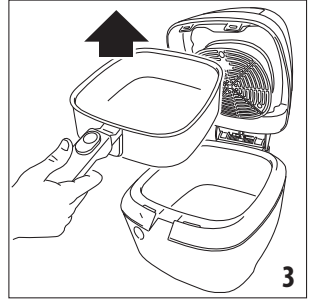
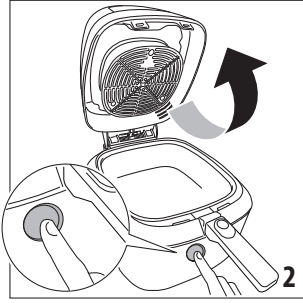
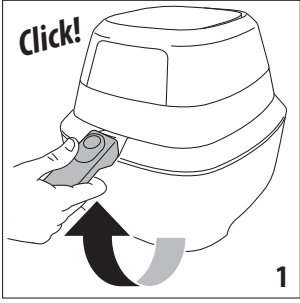

IMPORTANT SAFETY INSTRUCTIONS

The use of all electrical appliances implies the observance of some fundamental rules.

1. READ AND FOLLOW ALL INSTRUCTIONS
2. Do not touch hot surfaces. Use handles or knobs.
3. To protect against electrical shock do not immerse cord, plugs, or (state specific part or parts in question) in water or other liquid.
4. Close supervision is necessary when any appliance is used by or near children.
5. Unplug from outlet when not in use and before cleaning. Allow to cool before putting on or taking off parts.
6. Do not operate any appliance with a damaged cord or plug or after the appliance malfunctions or has been damaged in any manner. Return appliance to the nearest authorized service facility for examination, repair, or adjustment.
7. The use of accessory attachments not recommended by the appliance manufacturer may cause injuries.
8. Do not use outdoors.
9. Do not let cord hang over edge of table or counter, or touch hot surfaces.
10. Do not place on or near a hot gas or electric burner, or in a heated oven.
11. Always attach plug to appliance first, then plug cord into the wall outlet. To disconnect, turn any control to 'off', then remove plug from wall outlet.
12. Do not use appliance for other than intended use.
13. The use of accessory attachments not recommended by the appliance manufacturer may cause injuries.

SAVE THESE INSTRUCTIONS

THIS PRODUCT IS INTENDED FOR HOUSHOLD USE ONLY

WARNINGS

- Never immerse the appliance in water.
- When in operation, accessible external surfaces and the lid could become very hot. Always use the handgrip, handles and buttons.

Use oven gloves if necessary.

- This electrical appliance operates at high temperatures which could cause burns.
- Do not preheat the appliance when empty.
- Do not use the appliance without food, you might damage it.
- While in operation, the appliance becomes hot. DO NOT LEAVE WITHIN REACH OF CHILDREN.
- Move the appliance by the handles only. Never move the appliance using the bowl handgrip.
- Never leave the power cable hanging from the edge of the surface the appliance is resting on where it could be grasped by a child or get in the way of the user.
- Hot steam may come out of the vents. Take great care!
- Never locate the appliance near sources of heat.
- Never insert anything into the ventilation openings. Make sure they are unobstructed.
- Do not fill the bowl with liquid.
- Do not put more oil in the bowl than 1 1/2 tablespoon.
- Before using the appliance for the first time, remove any paper and other material inside the oven such as protective cardboard, booklets, plastic bags, etc.
- Before using the appliance for the first time, wash the bowl, paddle and lid in hot water and washing up liquid. At the end of the operation, dry all components thoroughly and remove any water left in the bottom of the bowl.
- It is normal for the appliance to give off a "new" smell when used for the first time. Ventilate the room.
- The appliance must be kept at a distance of at least 7.8 in from the mains power socket to which it is connected.

A short power-supply cord is provided to reduce the risk resulting from becoming entangled in or tripping over a longer cord. Longer detachable power-supply cords or extension cords are available and may be used if care is exercised in their use.

If a longer detachable power-supply cord or extension cord is used:

- 1) The marked electrical rating of the cord set or extension cord should be at least as great as the electrical rating of the appliance;
- 2) The cord should be arranged so that it will not drape over the countertop or tabletop where it can be pulled on by children or tripped over unintentionally; and
- 3) If the appliance is of the grounded type, the cord set or extension cord should be a grounding-type 3-wire cord.

TECHNICAL DATA

	FH2184	FH2394
size (LxHxD):	10.8x10.8x14.7in	10.8x11.6x14.7in
weight:	11.2lbs	12.3lbs

Frozen Potatoes

Maximum Capacity 2.2lbs 3.3lbs

For further information, see the rating plate on the appliance.

DESCRIPTION OF APPLIANCE

A Bottom heating element button

B Power level button

C Time adjust buttons

D Recipe selection button:



Potatoes



Pizza



Roast



Bake



Manual

E On/Off button

F Lid

G Removable viewing window

H Heat Convection grille

I Handle for lifting the appliance

L Main unit

M Lid open button

N Bowl handle

O Handgrip slide

P Bowl

SETTING UP THE APPLIANCE

i Please note: Before using the appliance for the first time, wash the bowl (P) and removable viewing window (G) in hot water and neutral washing liquid.



Proceed as follows:

- Lift the bowl handgrip (N) until you hear a 'click' (fig. 1).
- Open lid (F) by pressing button (M) (fig. 2).
- Extract the bowl (P) by pulling upwards (fig. 3).
- Release the removable viewing window (G); pulling it down (fig. 4).
- Wash the bowl and removable viewing window (fig. 5)
- At the end of operation, dry all components thoroughly and remove any water left in the bottom of the bowl.
- Replace the viewing window; align insert and push it up

into the lid (fig. 6).

- Insert the bowl (fig. 7).
- Close the lid (fig. 8).
- The appliance is ready to cook.

COOKING

- Put the bowl (P) back in the appliance, making sure it is correctly positioned.
- Lower the bowl handgrip (N) using the handgrip slide (O).
- Place the ingredients to be cooked in the bowl (P), respecting the quantities given in the cooking tables/recipes (on page 8-10).
- Close the lid (F).
- Plug the appliance into the main socket and the appliance is ready for  potatoes recipe (emits a 'beep').
- Select the desired preset function with recipe selection button (D).
- Adjust the cooking time with time adjust buttons (C).
- Adjust the power level (B) to the required level (see the cooking tables/recipes).
- If required by the cooking procedure, press the bottom heating element button (A) only for  manual preset function (see the cooking tables/recipes).
- If you make a mistake, you can set the new cooking time and power level.
- During cooking mode the available options are:
- Change the cooking time by increasing or decreasing the time button (C);
- Adjust the power level by increasing or decreasing the power level button (B);
- Press the On/Off button (E) to go in pause mode;
- If the lid is opened the appliance will go into pause mode;
- Keep the On/Off button (E) pressed longer to reset the cooking mode;
- During cooking, you can open the lid to add ingredients or check cooking progress. Ventilation stops briefly, then restart again when you close the lid.
- At the end of cooking the appliance will emit a 'beep'. If an extra cooking is required, press the time adjust buttons (C).

FRESH FRENCH FRIES

- Peel and cut the potatoes.
- Rinse potatoes under tap water.
- Dry the potatoes.
- Put the peeled potatoes (2.2 lb max FH2184, 3.3 lb max FH2394) in a mixing bowl and add one table spoon of oil (For optimal results, we suggest sunflower seed oil).
- Mix the potatoes and oil in a mixing bowl.
- Fill the air fryer (P) with the oiled potatoes.

- Close the lid (F) of appliance.
- Plug the appliance into the main socket. The appliance is ready for potatoes recipe (emits a 'beep').
- Adjust the power level by pressing the power level button (B).
- Adjust the cooking time with time adjust buttons (C).
- Press On/Off button (E).



Please note: During cooking operation the top surface and the back of the appliance could be hot. Don't touch this surfaces end keep away.

- At the middle cooking time lift the bowl handgrip until you hear a 'click' .
- Extract the bowl by pulling upwards
- Shake the potatoes
- Replace the bowl and close the lid
- At the end of cooking process the appliance will stop cooking and will emit a series of 'beeps'.

CLEANING AND MAINTENANCE



Danger! Before cleaning the appliance, always unplug from the mains socket and allow to cool.

Never immerse the appliance in water and never place under running tap water.

If water gets into the appliance, it could cause electric shock.

- Wash the bowl (P) and removable viewing window (G) thoroughly with hot water and neutral washing liquid.
- Clean the heat convection grille(H) without removing it.



Please note: Do not use sharp, abrasive or metallic utensils to remove food from the bowl as this can damage the ceramic coating. Clean with a soft cloth and neutral detergent only.

DE'LONGHI RAPID CRISP TEMPERATURE RECAP CHART - FH2184 & FH2394, CAVITY TEMPERATURES (*)











Temperature measured on center cavity of the air fryer

Function	Cavity average temperature			
	level 1 (min F°)	level 2 (min F°)	level 3 (min F°)	level 4 (min F°)
Potatoes	365	→→→→→		395
Pizza	330	→→→→→		375
Roast	310	→→→→→		365
Bake	320	→→→→→		345
Manual	260	300	375	395



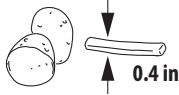
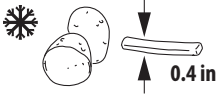
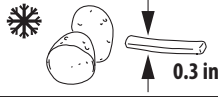











(*) average temperature; Indicative values subjected to variation due to production tolerance













Note: Consider that the cooking temperatures of this product will be lower than a conventional oven, due to the Duo Heat technology that uses two heating elements with a powerful combination of radiant and convection heat to surround and cook your food with accuracy and speed to provide perfect cooking results.













COOKING CHART















Potato function 	 Maximum Capacity		 min.				 Tbsp	
	FH2184	FH2394						
Fresh potatoes 	-	3.3 (*)	33-36	3	√	√ (beep)	√	1 ½
	2.7 (*)	2.7 (*)	28-30	3	√	√ (beep)	√	1
	2.2 (*)	2.2 (*)	23-25	3	√	√ (beep)	√	1
	1.6 (*)	1.6 (*)	20	3	√	√ (beep)	√	½
Frozen potatoes 	-	2.7	29-31	3	√	√ (beep)	√	-
	2.2	2.2	25-28	3	√	√ (beep)	-	-
	1.6	1.6	20-22	3	√	√ (beep)	-	-
	1.1	1.1	17	3	√	√ (beep)	-	-
Frozen potatoes 	-	2.7	29-31	3	√	√ (beep)	√	-
	2.2	2.2	23-26	3	√	√ (beep)	-	-
	1.6	1.6	18-20	3	√	√ (beep)	-	-
	1.1	1.1	15	3	√	√ (beep)	-	-
Hand-cut fresh potatoes 	-	3.3 (*)	33-36	4	√	√ (beep)	√	1 ½
	2.7 (*)	2.7 (*)	25-30	4	√	√ (beep)	√	1
Hand-cut frozen potatoes 	-	2.2	28-30	4	√	√ (beep)	-	-
	1.6	1.6	22-25	4	√	√ (beep)	-	-
Croquettes frozen potatoes 	-	2.2	23-25	4	√	√ (beep)	-	-
	1.6	1.6	18-20	4	√	√ (beep)	-	-

(*) un-peeled potato weight

Roast function 	 Maximum Capacity		 min.				 Tbsp
	FH2184	FH2394					
Chicken piece 	2.2	2.2	40-45	3	√	√	-
Meat and vegetable kebabs 	1.1	1.1	16-18	3	√	√	-
Hamburger 	0.9	0.9	10-12	3	√	√	1
Chicken 	2.6	2.6	42-45	3	√	-	-
Fish 	1.3	1.3	20-25	3	√	√	1
Shrimp 	1	1	8-10	4	√	-	1
Slice of salmon 	1.3	1.3	15-20	4	√	√	1

Pizza function 	 Maximum Capacity		 min.				 Tbsp
	FH2184	FH2394					
Pizza 	0.9	0.9	18-20	3	√	-	1
Quiche 	1.5	1.5	20-25	1	√	-	-
Frozen fish sticks 	1	1	8-10	3	√	√	1
Chicken nuggets 	0.5	0.5	8-10	3	√	√	1
Onion rings 	0.3	0.3	8-10	4	√	√	1

Bake function 	 Maximum Capacity		 min.				 Tbsp
	FH2184	FH2394					
Sponge cake 	1.6	1.6	30-35	3	√	-	-
Frozen croissant 	(x4) 0.5	(x4) 0.5	20-25	3	√	-	-
Cookies 	0.6	0.6	16-18	3	√	-	-
Muffins 	7-8 pcs	7-8 pcs	20-25	3	√	-	-
Donuts 	3-4 pcs	3-4 pcs	10-12	3	√	√	1

Manual function 	 Maximum Capacity		 min.				 tbsp
	FH2184	FH2394					
Cannelloni 	2.2	2.2	10-15	3	√	-	-
Ratatouille 	1.7	1.7	40-45	3	√	√	1
Scallops 	4 pcs	4 pcs	12-15	3	-	-	-
Tomato Gratin 	4 pcs	4 pcs	18-20	3	-	-	-
Sausage 	4 pcs	4 pcs	18-20	4	-	√	-
Bacon 	0.4	0.4	8-10	4	-	-	-
Meat 	3 pcs	3 pcs	18-20	4	-	√	-
Spare ribs 	1.1	1.1	20-25	4	-	√	-