

Brandt

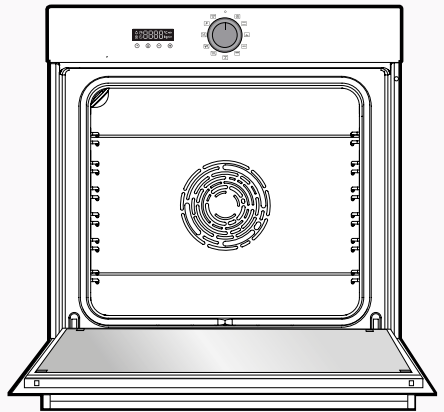

INSTRUCTIONS UTILISATEUR FR
USER INSTRUCTIONS EN
IMANUAL DE INSTRUCCIONES ES

FOUR
OVEN
HORNO



ORIGINE
FRANCE[®]
GARANTIE

CZ2100017

BYCert.6011825

Chère Cliente, Cher Client,

Vous venez d'acquérir un produit **BRANDT** et nous vous remercions de la confiance que vous nous accordez.

Nous avons conçu et fabriqué ce produit en pensant à vous, à votre mode de vie, à vos besoins, pour qu'il réponde au mieux à vos attentes. Nous y avons mis notre savoir-faire, notre esprit d'innovation et toute la passion qui nous anime depuis plus de 60 ans.

Dans un souci permanent de toujours mieux satisfaire vos exigences, notre service consommateurs est à votre disposition et à votre écoute pour répondre à toutes vos questions ou suggestions.

Connectez-vous aussi sur notre site **www.brandt.com** où vous trouverez nos dernières innovations, ainsi que des informations utiles et complémentaires.

BRANDT est heureux de vous accompagner au quotidien et vous souhaite de profiter pleinement de votre achat.



Le label « Origine France Garantie » assure au consommateur la traçabilité d'un produit en donnant une indication de provenance claire et objective. La marque BRANDT est fière d'apposer ce label sur les produits issus de nos usines françaises basées à Orléans et Vendôme.

Retrouvez-nous sur

<https://brandt.fr/>

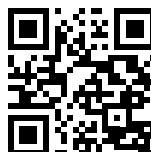

Important :

Avant de mettre votre appareil en marche, veuillez lire attentivement ce guide afin de vous familiariser plus rapidement avec son fonctionnement.



INSTRUCTIONS DE SÉCURITÉ	4
ENVIRONNEMENT ET ECONOMIE D'ENERGIE	6
Environnement	6
Conseil d'économie d'énergie.....	6
INSTALLATION DE VOTRE APPAREIL	7
Choix de l'emplacement et encastrement.....	7
Raccordement électrique.....	8
DESCRIPTION DE VOTRE APPAREIL	9
Présentation du four	9
Afficheur et touches de commandes	9
Accessoires	10
UTILISATION DE VOTRE APPAREIL	12
Réglages.....	12
Menu réglages.....	13
Les modes de cuisson	14
Démarrage d'une cuisson	15
ENTRETIEN DE VOTRE APPAREIL	17
Nettoyage intérieur - extérieur.....	18
ANOMALIES ET SOLUTIONS	19
SERVICE APRÈS-VENTE	21
Interventions	21
Relations consommateurs FRANCE	21
AIDE A LA CUISSON	21
Tableaux de cuissons.....	22
Recettes avec levure	24
Essais d'aptitude a la fonction.....	25
Fonctions avec vapeur combinées automatiques	26



Instructions de sécurité importantes lire avec attention et garder pour de futures utilisations.

Cette notice est disponible en téléchargement sur le site internet de la marque.

A la réception de l'appareil

Déballer-le ou faites le déballer immédiatement. Vérifiez son aspect général. Faites les éventuelles réserves par écrit sur le bon de livraison dont vous gardez un exemplaire.

Avant la 1ère utilisation

Chauffez votre four à vide pendant 15 minutes environ. Assurez-vous que la pièce est suffisamment aérée.

Informations importantes

Cet appareil a été conçu pour être utilisé par des particuliers dans leur lieu d'habitation. Ce four ne contient aucun composant à base d'amiante.

Votre appareil est destiné à un usage domestique normal. Ne l'utilisez pas à des fins commerciales ou industrielles ou pour d'autres buts que celui pour lequel il a été conçu.

Ne modifiez pas ou n'essayez pas de modifier les caractéristiques de cet appareil. Cela représenterait un danger pour vous.

Ne placez jamais de papier d'aluminium directement en contact

avec la sole, la chaleur accumulée pourrait entraîner une détérioration de l'émail.

Sur la porte ouverte du four, ne posez pas de charges lourdes, et assurez-vous qu'un enfant ne puisse ni monter ni s'asseoir.

Ne vous servez pas de votre four comme garde-manger ou pour stocker quelconques éléments après utilisation.

Après utilisation de votre four, assurez-vous que toutes les commandes se trouvent sur la position arrêt.

Pour toute intervention de nettoyage dans la cavité du four, le four doit être arrêté.

Avant de procéder au déclippage de la glace, laissez refroidir l'appareil.

Consignes de sécurité

- Cet appareil peut être utilisé par des enfants âgés de 8 ans et plus, et par des personnes aux capacités physiques, sensorielles ou mentales réduites, ou dénuées d'expérience et de connaissance, si elles ont pu bénéficier d'une



surveillance ou d'instructions préalables concernant l'utilisation de l'appareil de façon sûre et en ont compris les risques encourus. Les enfants ne doivent pas jouer avec l'appareil. Les opérations de nettoyage et de maintenance ne doivent pas être faites par des enfants laissés sans surveillance.

- Il convient de surveiller les enfants pour s'assurer qu'ils ne jouent pas avec l'appareil.

MISE EN GARDE :

- L'appareil et ses parties accessibles deviennent chaudes au cours de l'utilisation. Faire attention à ne pas toucher les éléments chauffants situés à l'intérieur du four. Les enfants de moins de 8 ans doivent être tenus à l'écart à moins qu'ils ne soient surveillés en permanence.

- Cet appareil est conçu pour faire des cuissons porte fermée.

- Avant de procéder à un nettoyage pyrolyse de votre four, retirez tous les accessoires et enlevez les éclaboussures importantes.

- Dans la fonction de nettoyage, les surfaces peuvent devenir plus chaudes qu'en usage normal. Il est recommandé d'éloigner les enfants.

- Ne pas utiliser d'appareil de nettoyage à la vapeur.

- Ne pas utiliser de produits d'entretien abrasifs ou de grattoirs métalliques durs pour nettoyer la porte en verre du four, ce qui pourrait érafler la surface et entraîner l'éclatement du verre.

MISE EN GARDE :

- S'assurer que l'appareil est déconnecté de l'alimentation avant de remplacer la lampe pour éviter tout risque de choc électrique. Intervenez lorsque l'appareil est refroidi. Pour devisser le hublot et la lampe, utilisez un gant de caoutchouc qui facilitera le démontage.

- La fiche de prise de courant doit être accessible après installation.

- Il doit être possible de déconnecter l'appareil du réseau d'alimentation, soit à l'aide d'une fiche de prise de courant, soit en incorporant un interrupteur dans les canalisations fixes conformément aux règles d'installation.

- Si le câble d'alimentation est endommagé, il doit être remplacé par le fabricant, son service après-vente ou une personne de qualification similaire afin d'éviter un danger.

- Cet appareil peut être installé indifféremment sous plan ou en colonne comme indiqué sur le schéma d'installation.



Installation de votre appareil

- Centrez le four dans le meuble de façon à garantir une distance minimum de 10 mm avec le meuble voisin.
- La matière du meuble d'encastrement doit résister à la chaleur (ou être revêtu d'une telle matière). Pour plus de stabilité, fixez le four dans le meuble par 2 vis au travers des trous prévus à cet effet sur les montants latéraux.
- L'appareil ne doit pas être installé derrière une porte décorative, afin d'éviter une surchauffe.



Environnement et économie d'énergie

ENVIRONNEMENT

Les matériaux d'emballage de cet appareil sont recyclables. Participez à leur recyclage et contribuez ainsi à la protection de l'environnement en les déposant dans les conteneurs municipaux prévus à cet effet.



Votre appareil contient également de nombreux matériaux recyclables. Il est donc marqué de ce logo afin de vous indiquer que les appareils usagés ne doivent pas être mélangés avec d'autres déchets.

Le recyclage des appareils qu'organise votre fabricant sera ainsi réalisé dans les meilleures conditions, conformément à la directive européenne en vigueur sur les déchets d'équipements électriques et électroniques.

Adressez-vous à votre mairie ou à votre revendeur pour connaître les points de collecte des appareils usagés les plus proches de votre domicile.

Nous vous remercions pour votre collaboration à la protection de l'environnement.

CONSEIL D'ÉCONOMIE D'ÉNERGIE

Pendant la cuisson, gardez la porte du four fermée.



CHOIX DE L'EMPLACEMENT ET ENCASTREMENT

Les schémas déterminent les côtes d'un meuble qui permettra de recevoir votre four. Cet appareil peut être installé indifféremment en colonne (A) ou sous plan (B). Si le meuble est ouvert, son ouverture doit être de 70 mm maximum à l'arrière (C et D). Fixez le four dans le meuble. Pour cela retirez les butées en caoutchouc et pré-percez un trou de \varnothing 2 mm dans la paroi du meuble pour éviter l'éclatement du bois. Fixez le four avec les 2 vis. Remplacez les butées caoutchouc.



Conseil :

Pour être assuré d'avoir une installation conforme, n'hésitez pas à faire appel à un spécialiste de l'électroménager.



Attention :

Si l'installation électrique de votre habitation nécessite une modification pour le branchement de votre appareil, faites appel à un électricien qualifié. Si le four présente une quelconque anomalie, débranchez l'appareil ou enlevez le fusible correspondant à la ligne de branchement du four.

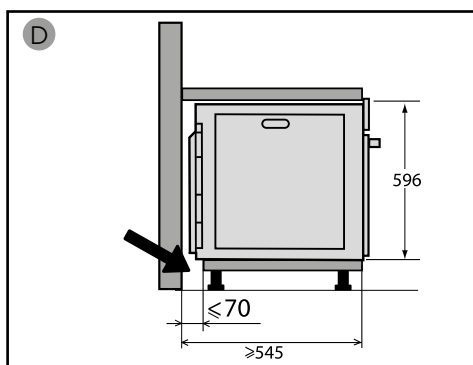
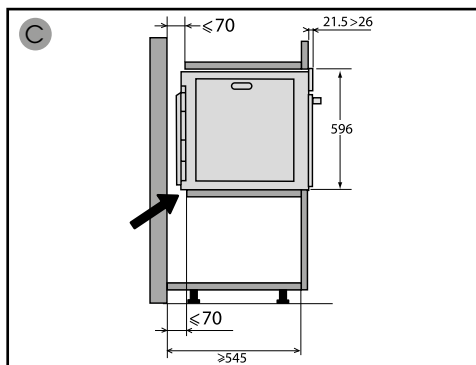
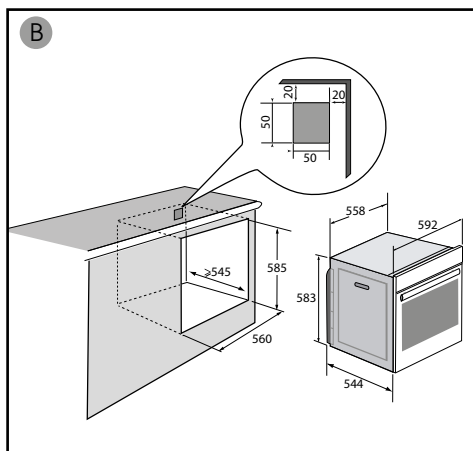
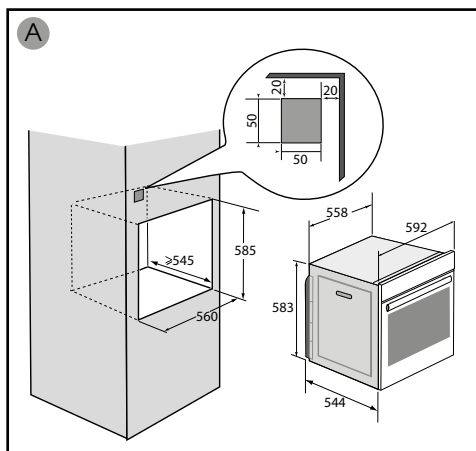



RACCORDEMENT ÉLECTRIQUE

Le four doit être branché avec un câble d'alimentation normalisé à 3 conducteurs de 1,5 mm² (1 ph + 1 N + terre) qui doivent être raccordés sur le réseau 220~240 Volts par l'intermédiaire d'une prise de courant normalisée CEI 60083 ou d'un dispositif de coupure omnipolaire conformément aux règles d'installation.



Attention

Le fil de protection (vert-jaune) est relié à la borne  de l'appareil et doit être relié à la terre de l'installation. Le fusible de l'installation doit être de 16 ampères.

Notre responsabilité ne saurait être engagée en cas d'accident ou d'incident consécutif à une mise à la terre inexistante, défectueuse ou incorrecte ni en cas de branchement non conforme.

• Avant la première utilisation

Avant d'utiliser votre four pour la première fois, chauffez-le à vide, porte fermée pendant 15 minutes environ sur la température la plus élevée. afin de roder l'appareil. La laine minérale qui entoure la cavité du four peut dégager au début une odeur particulière due à sa composition. De même, vous constaterez peut-être un dégagement de fumée. Tout ceci est normal.

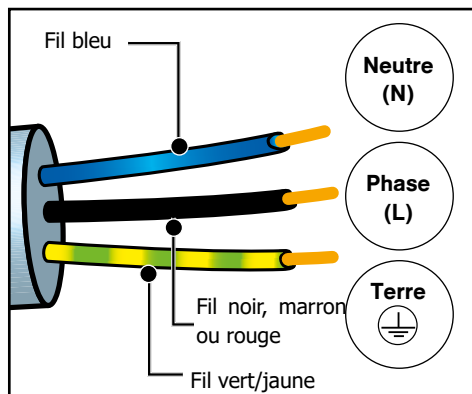



Présentation de votre appareil

PRÉSENTATION DU FOUR

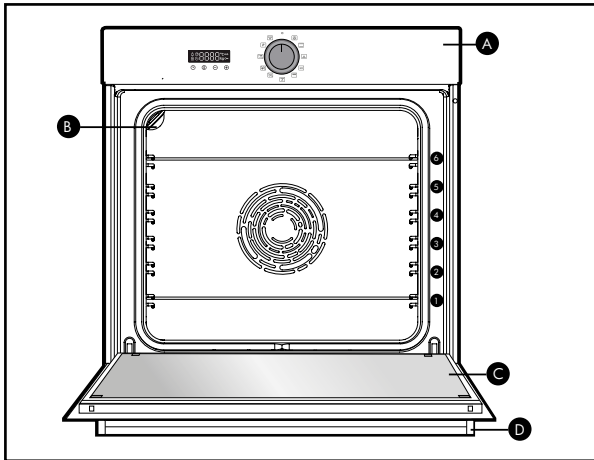

- A** Bandeau de commande
- B** Lampe
- C** Porte
- D** Poignée

Ce four dispose de 6 positions de gradins pour les accessoires : gradins de 1 à 6.

AFFICHEUR ET TOUCHES DE COMMANDES

• Afficheur



- Durée de cuisson
- Fin de cuisson
- Verrouillage clavier
- Minuterie
- Indicateur de température
- Indicateur de préchauffage
- Verrouillage porte

• Touches

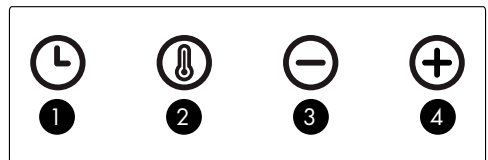

- 1** Réglage heure et durée
- 2** Réglage température
- 3** Touche -
- 4** Touche +



ACCESSOIRES

• Grille sécurité anti-basculement

La grille peut être utilisée pour supporter tous les plats et moules contenant des aliments à cuire ou à gratiner. Elle sera utilisée pour les grillades (à poser directement dessus).

Insérer la grille, sécurité anti-basculement vers le fond du four.

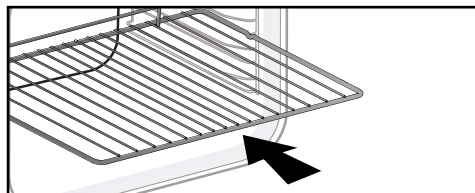

• Plat multi usages lèche-frites 45mm

A insérer dans les gradins sous la grille, poignée vers la porte du four. Il recueille les jus et les graisses des grillades, il peut être utilisé à demi rempli d'eau pour des cuissons au bain-marie.



• Plat Pâtisserie 20mm

Inséré dans les gradins poignée vers la porte du four. Idéal pour la cuisson de cookies, sablés, cupcake. Son pan incliné vous permet de déposer facilement vos préparations dans un plat. Peut aussi être inséré dans les gradins sous la grille, pour recueillir les jus et les graisses des grillades.

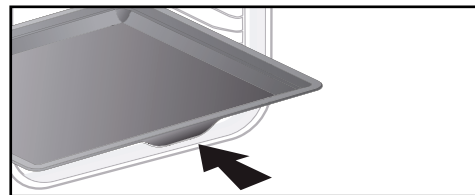

• Système de rails coulissants (selon modèle)

Grâce au système de rails coulissants, la manipulation des aliments devient plus pratique et facile puisque les plaques peuvent être sorties en douceur, ce qui simplifie au maximum leur manipulation. Les plaques peuvent être extraites entièrement, ce qui permet d'y accéder totalement. De plus, leur stabilité permet de travailler et de manipuler les aliments en toute sécurité, ce qui réduit le risque de brûlures. Ainsi, vous pouvez sortir vos aliments du four beaucoup plus aisément.

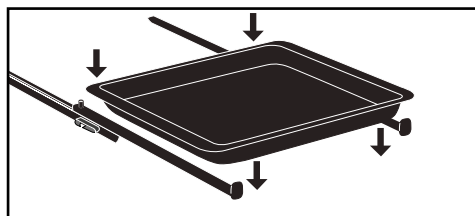

Mise en garde :

Retirez les accessoires et les gradins du four avant de démarrer un nettoyage par pyrolyse.

Mise en garde :

Sous l'effet de la chaleur les accessoires peuvent se déformer sans que cela n'altère leur fonction. Ils reprennent leur forme d'origine une fois refroidis.



Présentation de votre appareil

INSTALLATION ET DEMONTAGE DES RAILS COULISSANTS (selon modèle)

Après avoir retiré les 2 gradins-fils, choisissez la hauteur de gradins (de 2 à 5) à laquelle vous souhaitez fixer vos rails. Enclenchez le rail gauche contre le gradin gauche en effectuant une pression suffisante à l'avant et à l'arrière du rail afin que les 2 pattes sur le côté du rail rentrent dans le gradin-fil. Procédez de la même façon pour le rail droit.

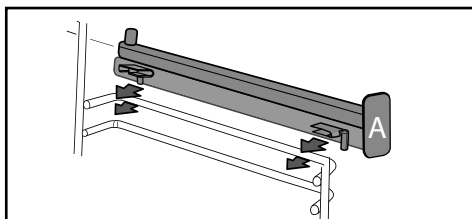

NOTA : la partie coulissante télescopique du rail doit se déplier vers l'avant du four, la butée **A** se trouve face à vous.

Mettez en place vos 2 gradins-fils et posez ensuite votre plaque sur les 2 rails, le système est prêt à l'utilisation.

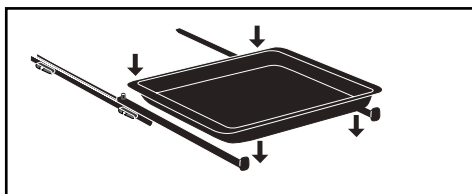

Pour démonter les rails, retirez à nouveau les gradins-fils.

Ecartez légèrement vers le bas les pattes fixées sur chaque rail pour les libérer du gradin. Tirez le rail vers vous.

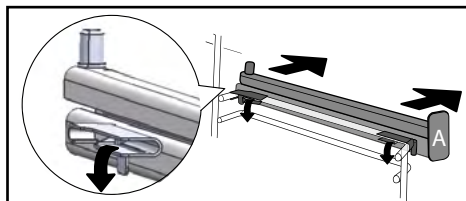

Conseil :

Afin d'éviter le dégagement de fumées durant la cuisson de viandes grasses, nous vous recommandons d'ajouter une faible quantité d'eau ou d'huile au fond de la lèche-frites.



RÉGLAGES

• Mise à l'heure

A la mise sous tension l'afficheur clignote à 12:00.

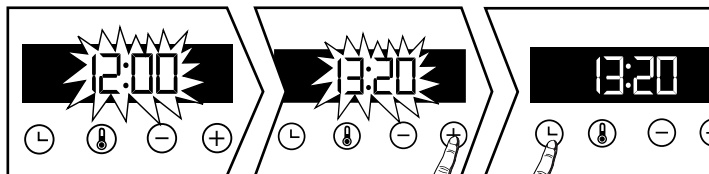



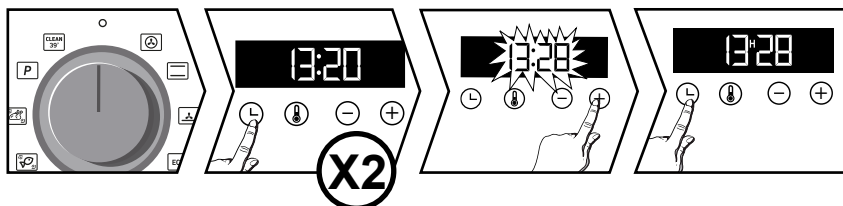

Réglez l'heure avec les touches + ou -. Validez avec la touche . En cas de coupure de courant l'heure clignote.

• Modification de l'heure

Le sélecteur de fonction doit obligatoirement être sur la position 0.





Appuyez sur la touche  le symbole  apparaît appuyez de nouveau sur . Ajustez le réglage de l'heure avec les touches + ou -. Validez avec la touche . L'enregistrement, de l'heure ajustée est automatique, au bout de quelques secondes.

• Minuterie

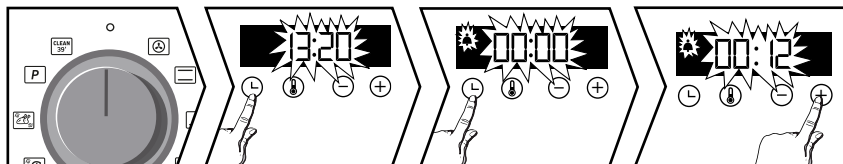
Cette fonction ne peut être utilisée que four à l'arrêt.



Le sélecteur de fonction doit obligatoirement être sur la position 0.



Appuyez sur la touche  le symbole  apparaît. Ajustez le réglage de l'heure avec les touches + ou -. Validez avec la touche .

NB : Vous avez la possibilité de modifier ou d'annuler la programmation de la minuterie à n'importe quel moment. Pour annuler, retournez au menu de la minuterie et réglez sur 00:00. Sans validation, l'enregistrement s'effectue automatiquement au bout de quelques secondes.

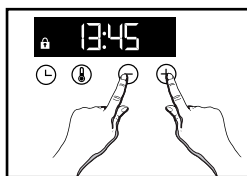

• Verrouillage clavier (sécurité enfants)





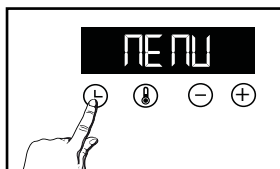

Appuyez simultanément sur les touches + et - jusqu'à l'affichage du symbole  à l'écran. Pour le déverrouiller, simultanément sur les touches + et - jusqu'à ce que le symbole  disparaisse de l'écran.

MENU RÉGLAGES

Vous pouvez intervenir sur différents paramètres de votre four, pour cela: Appuyez sur la touche  jusqu'à l'affichage de "MENU" pour accéder au mode de réglage.



Appuyez de nouveau sur la touche  afin de faire défiler les différents réglages. Activez ou désactivez avec les touches + et - les différents paramètres, voir tableau ci-après:

	AUTO: En mode cuisson la lampe de la cavité s'éteint au bout de 90 secondes ON: En mode cuisson la lampe est tous le temps allumé.
	Activez/désactivez les bips des touches
	Activez/désactivez le mode préchauffage
	Activez/désactivez le mode démonstration

Pour sortir du "MENU" appuyez de nouveau sur .



Utilisation de votre appareil

MODES DE CUISSON (selon modèle)

Fonctions manuelles :



CHALEUR TOURNANTE*

Température mini 35°C maxi 250°C

Recommandé pour garder le moelleux des viandes blanches, poissons, légumes. Pour les cuissons multiples jusqu'à 3 niveaux.



TRADITIONNEL

Température mini 35°C maxi 275°C

Recommandé pour les cuissons lentes et délicates: gibiers moelleux. Pour saisir rôtis de viande rouge. Pour mijoter en cocotte fermée des plats préalablement démarrés sur table de cuisson (coq au vin, civet).



ECO*

Température mini 35°C maxi 275°C

Cette position permet de faire un gain d'énergie tout en conservant les qualités de cuisson. Toutes les cuissons se font sans préchauffage.



GRIL FORT

Température mini 180°C maxi 275°C

Recommandée pour griller des toasts, gratiner un plat, dorer une crème brûlée...



GRIL PULSE

Température mini 100°C maxi 250°C

Volailles et rôtis juteux et croustillants sur toutes les faces.

Glissez la lèchefrite au gradin du bas.

Recommandé pour toutes les volailles ou rôtis, pour saisir et cuire à cœur gigot, côtes de boeuf. Pour garder leur fondant aux pavés de poissons.

Fonctions automatiques :

Brandt vous propose 3 nouvelles fonctions qui combinent, de façon automatique, deux modes de cuisson : la cuisson traditionnelle et la cuisson vapeur afin de préserver les qualités nutritionnelles des aliments et d'obtenir une cuisson plus rapide.



VIANDES BLANCHES

Recommandé pour conserver le moelleux et le fondant des rotis de porc et de veau.



POISSONS

Recommandé pour la cuisson des poissons entiers ou en filets.



VOLAILLES

Recommandé pour la cuisson des poulets, dindes, pintades et canards.

Pour ces 3 fonctions il vous suffit d'introduire de l'eau tiède en quantité suffisante dans votre plat (lèchefrite) et de le positionner dans votre four au gradin du bas et votre aliment à cuire au gradin niveau 3.

Concernant la quantité d'eau à introduire dans la lèchefrite, reportez-vous au tableau des fonctions combinées automatiques avec association de vapeur en fin de notice.



Système "Smart Assist"

Votre four est équipé de la fonction "Smart Assist" qui lors d'une programmation de durée, vous préconisera une durée de cuisson modifiable selon le mode de cuisson choisi.

**Mode de cuisson réalisé selon les prescriptions de la norme EN 60350-1 : 2016 pour démontrer la conformité aux exigences d'étiquetage énergétique du règlement européen UE/65/2014.*



DÉMARRAGE D'UNE CUISSON

• Démarrage d'une cuisson immédiate

Le programmateur ne doit afficher que l'heure. Celle-ci ne doit pas clignoter. Tournez le sélecteur de fonctions sur la position de votre choix.

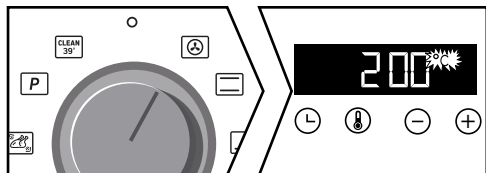



Pour les fonctions manuelles :

La montée en température démarre immédiatement. Votre four vous préconise une température, modifiable. Le four chauffe et l'indicateur de température clignote. Une série de bips sonores retentit lorsque le four atteint la température programmée.

Pour les fonctions automatiques :

 s'affiche à l'écran.

Sélectionnez votre aliment à l'aide du tableau en fin de notice. Appuyez sur les touches + et - jusqu'à obtenir le schéma souhaité dans l'afficheur puis validez avec la touche .

Un poids clignote ; rentrez le poids réel de votre aliment avec les touches + et - puis validez .

Vous n'avez rien d'autre à régler, la température et la durée de cuisson sont calculées automatiquement. L'heure de fin de cuisson clignote, validez avec la touche . Votre cuisson démarre aussitôt.



• Modification de la température

Appuyez sur .

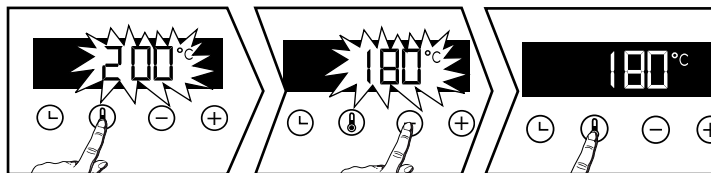
Ajustez la température avec + ou -. Validez en appuyant sur .



• Modification de la durée

Effectuez une cuisson immédiate ensuite appuyez sur , la durée de cuisson  clignote, le réglage est alors possible. Appuyez sur + ou - pour régler la durée de cuisson.

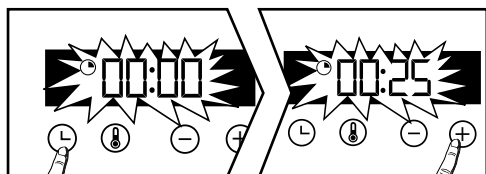





Système "Smart Assist"

Votre four est équipé de la fonction "Smart Assist" qui lors d'une programmation de durée, vous préconisera une durée de cuisson modifiable selon le mode de cuisson choisi (voir tableau).

L'enregistrement du temps de cuisson est automatique au bout de quelques secondes. Le décompte de la durée se fait immédiatement une fois la température de cuisson atteinte.

FONCTION DE CUISSION	DURÉE
	30 min
	30 min
	30 min
	7 min
	15 min

• Modification de l'heure de fin de cuisson

Procédez comme une durée programmée. Après le réglage de la durée de cuisson, appuyez sur la touche , l'heure de fin de cuisson  clignote.

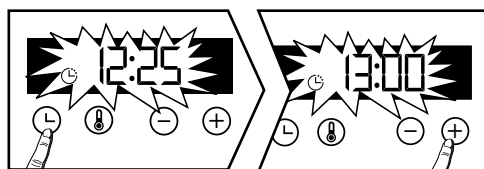

L'affichage clignote, réglez l'heure de fin de cuisson avec + ou -.

L'enregistrement de la fin de cuisson est automatique au bout de quelques secondes. L'affichage de la fin de cuisson ne clignote plus.



Entretien de votre appareil

NETTOYAGE INTÉRIEUR - EXTÉRIEUR

• Nettoyage de la cavité par pyrolyse





Attention

Retirez les accessoires et les gradins-fils du four avant de démarrer un nettoyage par pyrolyse. Avant de procéder à un nettoyage pyrolyse de votre four, enlevez les débordements importants qui auraient pu se produire. Enlevez le surplus de graisse sur la porte à l'aide d'une éponge humide.

Par mesure de sécurité, l'opération de nettoyage par pyrolyse ne s'effectue qu'après blocage automatique de la porte, il est impossible de déverrouiller la porte.

• Autonettoyage immédiat

Le programmeur doit afficher l'heure du jour, sans clignoter. Sélectionnez un des cycles d'autonettoyage avec la manette de fonctions  ou  :

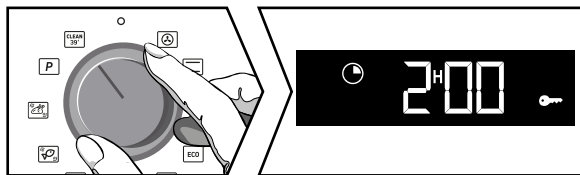





= **Nettoyage en 39 minutes**

- A chaque fin de cuisson «Clean 39» défile à l'écran vous proposant de lancer ce nettoyage. Positionnez la manette sur cette fonction et validez avec la touche . La durée 0:39 s'affiche en alternance avec «Clean 39», votre nettoyage démarre. Au bout de quelques minutes une clé apparaît, la porte du four est alors verrouillée automatiquement par mesure de sécurité durant tout le programme.

Si vous souhaitez lancer un «Clean 39» four froid ou pas suffisamment chaud, les conditions de lancement du programme ne permettront pas ce nettoyage. 0:00 s'affichera à l'écran, vous devrez alors choisir l'autre position d'autonettoyage .

= **Pyrolyse de 2 heures ou d'1 heure 30**, au choix. Positionnez la manette sur cette fonction.



Positionnez la manette sur cette fonction.  s'affiche à l'écran. Appuyez sur + pour choisir votre pyrolyse en fonction du degré de salissure de votre four.

Selon votre choix, la durée 2:00 (ou 1:30) s'affiche. Validez avec la touche .  (ou ) s'affiche, la pyrolyse démarre.

A la fin du nettoyage l'afficheur indique 0:00 et la porte se déverrouille.

Ramenez le sélecteur de fonctions sur 0.

• Autonettoyage différée

Vous avez la possibilité de différer le départ de votre Pyrolyse. Lorsque la durée du programme s'affiche à l'écran, appuyez sur la touche  et réglez la nouvelle heure de fin avec les touches + et - puis validez avec . L'autonettoyage commencera ultérieurement pour terminer à la nouvelle heure programmée. Remettez le sélecteur de fonctions sur 0 à la fin du nettoyage.



Entretien de votre appareil

• Nettoyage de la surface extérieure

Utilisez un chiffon doux, imbibé de produit à vitre. N'utilisez pas de crèmes à récurer, ni d'éponge grattoir.

• Nettoyage des gradins-fils

Démontez les gradins-fils pour les nettoyer. Soulevez la partie avant du gradin vers le haut ; poussez l'ensemble du gradin et faites sortir le crochet avant de son logement. Tirez ensuite légèrement l'ensemble du gradin vers vous afin de faire sortir les crochets arrières de leur logement. Retirez ainsi les 2 gradins.

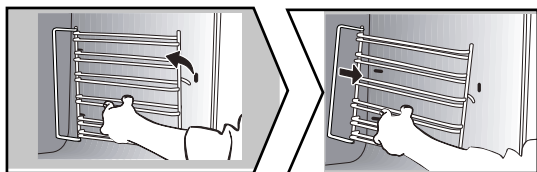

• Nettoyage des vitres de la porte

Attention :

Ne pas utiliser de produits d'entretien à récurer, d'éponge abrasive ou de grattoirs métalliques pour nettoyer la porte en verre du four, ce qui pourrait érafler la surface et entraîner l'éclatement du verre.

Au préalable enlevez avec un chiffon doux et du liquide vaisselle le surplus de graisse sur la vitre intérieure.

Pour nettoyer les différentes vitres intérieures, procédez au démontage de celles-ci de la façon suivante :

• Nettoyage des vitres de la porte

Ouvrez complètement la porte et bloquez-la à l'aide de la câle plastique fournie dans la pochette plastique de votre appareil.

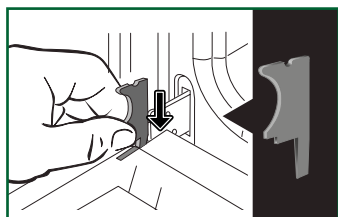

Retirez la première vitre clipée : appuyez à l'aide d'un outil (tournevis) dans les emplacements (A) afin de déclipper la vitre puis retirez-la.

Important :

Veillez à bien repérer le sens de montage de cette 1ère vitre (face brillante vers vous)



Entretien de votre appareil

Selon modèle la porte est composée de deux vitres supplémentaires avec à chaque coin une entretoise noire en caoutchouc. Si nécessaire, retirez-les pour les nettoyer.

Ne pas immerger les vitres dans l'eau. Rincez à l'eau claire et essuyez avec un chiffon non pelucheux.

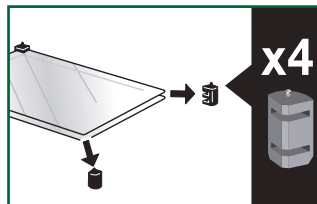
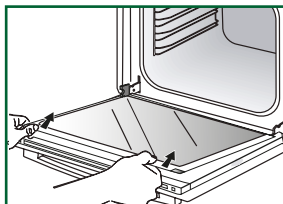
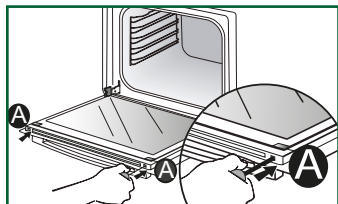

• Remontage des vitres de la porte

Après nettoyage, repositionnez les quatre butées en caoutchouc flèche vers le haut et repositionnez l'ensemble des vitres.

Engagez la dernière vitre dans les butées métalliques, ensuite clippez-la, face brillante vers vous. Retirez la câle plastique.

Votre appareil est de nouveau opérationnel.

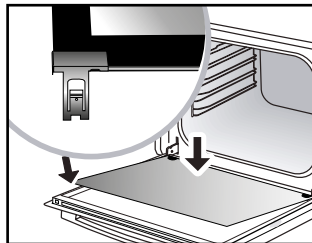
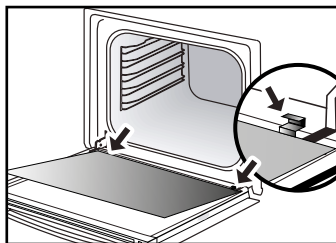
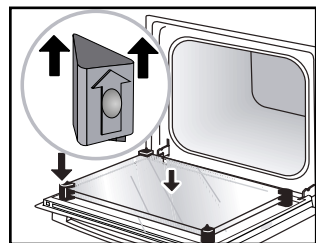

• Remplacement de la lampe

⚠ Important :
Assurez-vous que l'appareil est déconnecté de l'alimentation avant de remplacer la lampe pour éviter tout risque de choc électrique. Intervenez lorsque l'appareil est refroidi.

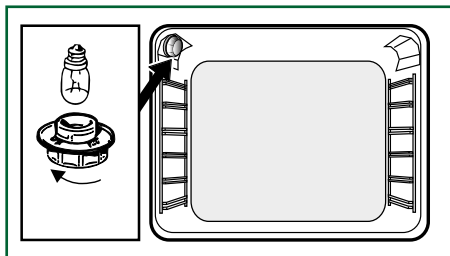

Caractéristiques de l'ampoule :

25 W, 220-240 V~, 300°C, culot G9.

Vous pouvez remplacer vous-même la lampe lorsqu'elle ne fonctionne plus. Dévissez le hublot puis sortez la lampe (utilisez un gant de caoutchouc qui facilitera le démontage). Insérez la nouvelle lampe et remplacez le hublot.



ANOMALIES ET SOLUTIONS

Le four ne chauffe pas.

Vérifiez si le four est bien branché ou si le fusible de votre installation n'est pas hors service. Augmentez la température sélectionnée.

La lampe du four ne fonctionne pas.

Remplacez l'ampoule ou le fusible. Vérifiez si le four est bien branché.

Le ventilateur de refroidissement continue de tourner à l'arrêt du four.

C'est normal, la ventilation peut fonctionner jusqu'à une heure maxi après la cuisson pour faire baisser la température intérieure et extérieure du four. Au-delà d'une heure, contactez le Service Après Vente.

Le nettoyage par pyrolyse ne se fait pas.

Vérifiez la fermeture de la porte. Il peut s'agir d'un défaut de verrouillage de la porte ou du capteur de température. Si le défaut persiste, contactez le Service Après-Vente.

Le symbole clignote dans l'afficheur.

Défaut de verrouillage de la porte, faites appel au Service Après Vente.

Bruit de vibration.

Vérifiez que le cordon d'alimentation ne soit pas en contact avec la paroi arrière.

Ceci n'a pas d'impact sur le bon fonctionnement de votre appareil mais peut néanmoins générer un bruit de vibration pendant la ventilation. Retirez votre appareil et déplacez le cordon. Remplacez votre four.



INTERVENTIONS

Les éventuelles interventions sur votre appareil doivent être effectuées par un professionnel qualifié dépositaire de la marque. Lors de votre appel, afin de faciliter la prise en charge de votre demande, munissez-vous des références complètes de votre appareil (référence commerciale, référence service, numéro de série). Ces renseignements figurent sur la plaque signalétique.

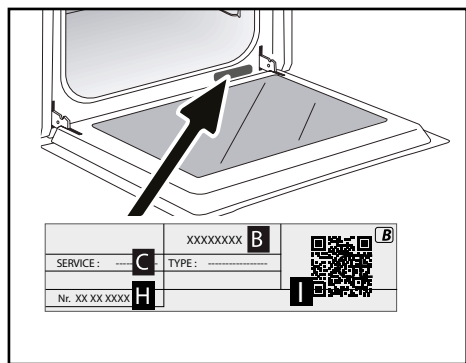

B : Référence commerciale

C : Référence service

H : Numéro de série

I : QR Code

Vous pouvez nous contacter du lundi au samedi de 8h00 à 20h00 au :

09 69 39 25 25 Service gratuit + prix appel

RELATIONS CONSOMMATEURS FRANCE

Pour en savoir plus sur nos produits ou nous contacter, vous pouvez :

> consulter notre site :

www.brandt.com

> nous écrire à l'adresse postale suivante :

Service Consommateurs SAUTER

5 avenue des Béthunes

CS69526 SAINT OUEN L'AUMONE

95060 CERGY PONTOISE CEDEX









> nous appeler du lundi au vendredi de 8h30 à 18h00 au :

09 69 39 25 25 Service gratuit + prix appel

PIÈCES D'ORIGINE

Lors d'une intervention, demandez l'utilisation exclusive de pièces détachées certifiées d'origine.



PLATS	       												min
Viandes													
Rôti de porc (1kg)	200	2					180	2				60	
Rôti de veau (1kg)	200	2					180	2				60-70	
Rôti de boeuf	240	2										30-40	
Agneau (gigot, épaule 2,5 kg)	220	1			220					200	2	60	
Volailles (1 kg)	200	2			220		180	2		210	3	60	
Volailles grosses pièces	180	1										60-90	
Cuisses de poulet					220	3				210	3	20-30	
Côtes de porc / veau					210	3						20-30	
Côtes de boeuf (1kg)					210	3				210	3	20-30	
Côtes de mouton					210	3						20-30	
Poissons													
Poissons grillés					275	4						15-20	
Poissons cuisinés	200	3					180	3				30-35	
Poissons papillottes	220	3					200	3				15-20	
Légumes													
Gratins (aliments cuits)					275	2						30	
Gratins dauphinois	200	2					180	2				45	
Lasagnes	200	3					180	3				45	
Tomates farcies	170	3					160	2				30	
Pâtisseries													
Biscuit de Savoie - Génoise			180	2						180	2	35	
Biscuit roulé	220	3								180	2	5-10	
Brioche	180	1	210							180	2	35-45	
Brownies	180	2					175	3				20-25	
Cake - Quatre-quarts	180	1	180	1						180	2	45-50	
Clafoutis	200	2					180	3				30-35	
Crèmes	165	2								150	2	30-40	
Cookies - Sablés	175	3										15-20	
Kugelhopf			180	2						180	2	40-45	
Meringues	100	2								100	3	60-70	

* Selon modèle

PLATS									
									min

Pâtisseries

Madeleines	220	3					200	3									5-10
Pâtes à choux	200	3					180	3					180	3			30-40
Petits fours feuilletés	220	3					200	3									5-10
Savarin	180	3											175	3			30-35
Tarte pâte Brisée	200	1					195	1									30-40
Tarte pâte feuilletée fine	215	1					200	1									20-25
Tarte pâte à levure	210	1					200	1									10-30

Divers

Brochettes	220	3			210	4											10-15
Pâté en terrine	200	2					190	2									80-100
Pizza pâte Brisée	200	2															30-40
Pizza pâte à pain																	15-18
Quiches																	35-40
Soufflé													180	2			50
Tourtes	200	2															40-45
Pain	220						200		220								30-40
Pain grillé	180				275	4-5											2-3
Cocottes fermées (daube)	180	2											180	2			90-180

* Selon modèle

⚠ Toutes les T°C et temps de cuisson sont donnés pour des fours

N.B: Avant d'être mises au four, toutes les viandes doivent rester au moins 1 heure à température ambiante.

EQUIVALENCE : CHIFFRES T °C									
°C	30	60	90	120	150	180	210	240	275
Chiffres	1	2	3	4	5	6	7	8	9 maxi

Recette avec levure (selon modèle)

Ingrédients:

● Farine 2 kg ● Eau 1240 ml ● Sel 40 g ● 4 paquets de levure de boulanger déshydratée







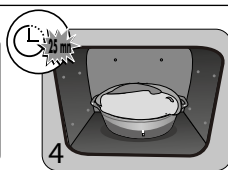











Mélanger la pâte avec le mixer et faire lever la pâte dans le four.

Procédure: Pour les recettes de pâtes à base de levure. Verser la pâte dans un plat résistant à la chaleur, retirer les supports de gradins fils et placer le plat sur la sole.

Préchauffez le four avec la fonction chaleur tournante à 40-50 °C pendant 5 minutes. Arrêtez le four et laissez lever la pâte 25-30 minutes grâce à la chaleur résiduelle.















ESSAIS D'APTITUDE A LA FONCTION SELON LA NORME CEI 60350

ALIMENT	*Mode de cuisson	NIVEAU	Accessoires	°C	DUREE min.	PRECHAUF-FAGE
Sablés (8.4.1)		5	plat 45 mm	150	30-40	oui
Sablés (8.4.1)		5	plat 45 mm	150	25-35	oui
Sablés (8.4.1)		2 + 5	plat 45 mm + grille	150	25-45	oui
Sablés (8.4.1)		3	plat 45 mm	175	25-35	oui
Sablés (8.4.1)		2 + 5	plat 45 mm + grille	160	30-40	oui
Petits cakes (8.4.2)		5	plat 45 mm	170	25-35	oui
Petits cakes (8.4.2)		5	plat 45 mm	170	25-35	oui
Petits cakes (8.4.2)		2 + 5	plat 45 mm + grille	170	20-40	oui
Petits cakes (8.4.2)		3	plat 45 mm	170	25-35	oui
Petits cakes (8.4.2)		2 + 5	plat 45 mm + grille	170	25-35	oui
Gâteau moelleux sans matière grasse (8.5.1)		4	grille	150	30-40	oui
Gâteau moelleux sans matière grasse (8.5.1)		4	grille	150	30-40	oui
Gâteau moelleux sans matière grasse (8.5.1)		2 + 5	plat 45 mm + grille	150	30-40	oui
Gâteau moelleux sans matière grasse (8.5.1)		3		150	30-40	oui
Gâteau moelleux sans matière grasse (8.5.1)		2 + 5	plat 45 mm + grille	150	30-40	oui
Tourte aux pommes (8.5.2)		1	grille	170	90-120	oui
Tourte aux pommes (8.5.2)		1	grille	170	90-120	oui
Tourte aux pommes (8.5.2)		3	grille	180	90-120	oui
Surface gratinée (9.2.2)		5	grille	275	3-6	oui

* Selon modèle

NOTA : Pour les cuissons à 2 niveaux, les plats peuvent être sortis à des temps différents.

TABLEAU DES FONCTIONS COMBINÉES AUTOMATIQUES AVEC ASSOCIATION DE VAPEUR

Position de la manette	Affichage dans programmeur	Aliments	Quantité d'eau à ajouter
		Poulet	500 ml d'eau tiède dans la lèchefrite
		Canard	500 ml d'eau tiède dans la lèchefrite
		Dinde	500 ml d'eau tiède dans la lèchefrite
		Pintade	800 ml d'eau tiède dans la lèchefrite
		Poissons entiers (gros)	500 ml d'eau tiède dans la lèchefrite
		Poissons entiers (plats)	300 ml d'eau tiède dans la lèchefrite
		Petits poissons entiers	300 ml d'eau tiède dans la lèchefrite
		Filets de poissons	300 ml d'eau tiède dans la lèchefrite
		Rôti de porc	500 ml d'eau tiède dans la lèchefrite
		Rôti de veau	500 ml d'eau tiède dans la lèchefrite

IMPORTANT

Positionnez la lèchefrite (avec l'eau tiède) au gradin du bas, niveau 1 et votre aliment à cuire au gradin niveau 3.

Brandt



USER INSTRUCTIONS EN

OVEN

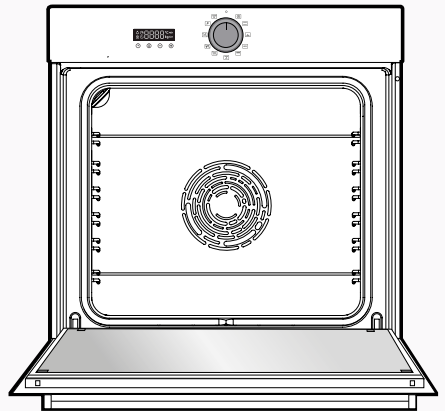

Dear Customer,

You have just acquired a **BRANDT** product and we would like to thank you.

We have designed and made this product with you, your lifestyle and your requirements in mind so that it meets your expectations. We have devoted our know-how, our innovative spirit and the passion that has been guiding us for over 60 years.

In an effort to ensure that our products meet your requirements in the best possible way, our Customer Relations department is at your disposal, to answer all your questions and to listen to all your suggestions.

Visit our website www.brandt.com where you will find our latest innovations, as well as useful and complementary information.

BRANDT is delighted to assist you every day and hopes you get the most out of your purchase.



The label "Origine France Garantie" assures the consumer the traceability of a product by giving a clear and objective indication of the source. Brandt brand is proud to affix this label on products from our French factories based in Orléans and Vendôme.

BVCert.6011825

<https://brandt.com/>



Important: Before using your appliance, read this user guide carefully to familiarise yourself more quickly with its operation.



Table of Contents

SAFETY INSTRUCTIONS	4
ENVIRONMENT	6
Environment	6
Energy saving councils	6
INSTALLATION	7
Choice of location and fitting	7
Electrical connection.....	8
DESCRIPTION OF THE OVEN	9
Presentation of the oven	9
Display and buttons	9
Accessories.....	10
HOW TO USE YOUR APPLIANCE	12
Setting	12
Setting menu	12
Cooking mode.....	14
Starting cooking.....	15
CLEANING	17
Cleaning inside - outside	18
ANOMALIES AND SOLUTIONS	20
SERVICE CALLS	21
Service calls.....	21
COOKING AID	21
Cooking tables.....	22
Recipes with yeast	24
Performance testing.....	25
Automatic combined steam functions	26



IMPORTANT - READ CAREFULLY AND RETAIN FOR FUTURE USE.

This user guide is available for download on the brand's web-site.

When you receive the appliance, unpack it or have it unpacked immediately. Check its general appearance. Make a note of any reservations on the delivery slip and keep a copy.



Important:

This appliance may be used by children aged 8 years and older, and by persons with impaired physical sensorial or mental capacities, or without experience or knowledge, if they are supervised or have received prior instructions on how to use the appliance safely and have understood the risks involved. Children must not be allowed to play with the appliance. Cleaning and maintenance operations must not be carried out by children without supervision.

— Children must be supervised to prevent them from playing with the appliance.



WARNING:

— The appliance and its accessible parts become hot during use. Be

careful not to touch the heating elements inside the oven. Children under 8 years old must not be allowed near it unless they are supervised at all times.

— This appliance is designed to cook with the door closed.

— Before pyrolytic cleaning of your oven, remove all accessories and any thick deposits.

— During cleaning, the surfaces may become warmer than under normal conditions of use. It is advisable to keep children away from the appliance.

— Do not use a steam cleaner.

— Do not use abrasive cleaning products or hard metal scrapers for cleaning the oven's glass door, as they could scratch the surface and cause the glass to shatter.



WARNING :

Make sure the appliance is disconnected from the power before replacing the lamp in order to avoid the risk of electric shock. Change the lamp only when the appliance has cooled down. To unscrew the view port and the light, use a rubber glove, which will make disassembly easier.



The electrical plug must remain accessible after installation.

— It must be possible to disconnect the appliance from the power supply, either using a plug or by fitting a switch on the fixed wiring system in accordance with installation rules.

— If the power cable is damaged, it should be replaced by the manufacturer, its after-sales service department or by a similarly qualified person in order to avoid danger.

— This appliance may be installed either under a worktop or in a cabinet column, as indicated on the installation diagram.

— Centre the oven in the unit so as to ensure a minimum distance of 10 mm between the appliance and the surrounding unit. The material of the unit supporting the appliance must be heat-resistant (or covered with a heat-resistant material). For greater stability, attach the oven to the unit with 2 screws through the holes provided on the side panels.

— In order to avoid overheating, the appliance must not be installed behind a decorative door..

— This appliance is designed to be used for domestic and similar

applications such as:

Kitchen areas for the staff of shops, offices and other professional premises; Farms; Use by clients of hotels, motels and other residential type establishments; guest house type environments.

— The oven must be turned off when cleaning inside the oven.

Do not modify the characteristics of this appliance; doing so could be dangerous.

Do not use your oven as a larder or to store any items after use.



CARE FOR THE ENVIRONMENT

- This appliance's packing materials are recyclable. Please recycle them and help protect the environment by depositing them in municipal containers provided for this purpose.

- Your appliance also contains many recyclable materials. It is therefore marked with this logo to indicate that used appliances must not be mixed with other waste.

The appliance recycling organised by your manufacturer will therefore be conducted in optimum conditions, in accordance with European directive 2002/96/EC on electrical and electronic equipment waste.

Consult your local authority or your retailer to locate your nearest used appliance drop-off points.

- We thank you for your help in protecting the environment.

ENERGY SAVING COUNCIL

Keep the oven door closed during baking.



CHOICE OF LOCATION AND FITTING

The diagrams show the dimensions of a cabinet that will be able to hold your oven.

This appliance may be installed either under a worktop (A) or in a column (B). If the cabinet is open, its opening at the back must be 70 mm maximum.

Install the oven in the furniture. To do this, remove the rubber stops and pre-drill a 2-mm diameter hole in the wall of the furniture to avoid splitting the wood. Attach the oven with the two screws. Re-position the rubber stops.



Tip

To be certain that you have properly installed your appliance, do not hesitate to call on a household appliance specialist.



Warning :

If the electrical installation in your residence requires any changes in order to hook up your appliance, contact a professional electrician. If the oven malfunctions in any way, unplug the appliance or remove the fuse corresponding to the sector where the oven is hooked up.

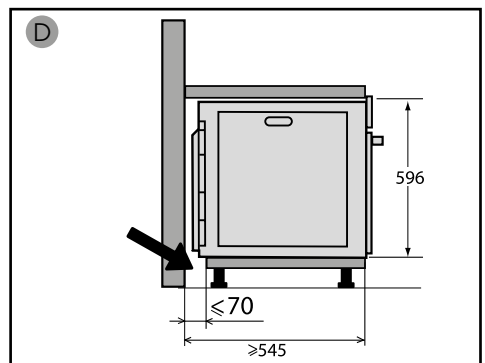
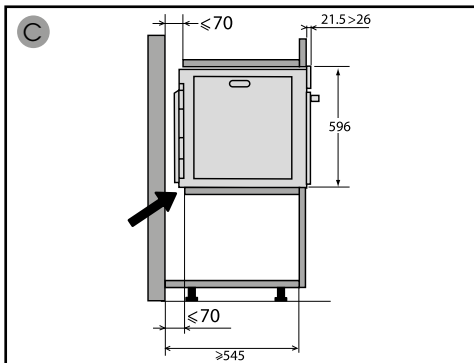
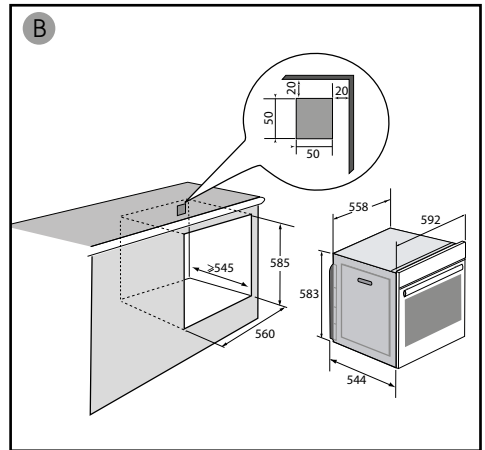
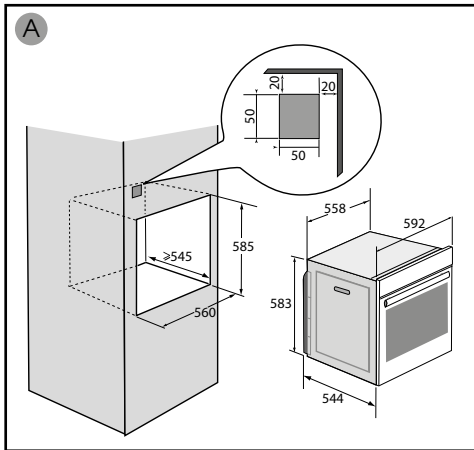



ELECTRICAL CONNECTION

Your oven must be connected with a (standard) power cable with 3 conductors of 1.5mm² (1 live + 1 neutral + earth) which must be connected to a 220-240V_~ single-phase grid by means of a 1 live + 1 neutral + earth CEI 60083 standard power socket or via an all-poles cut-off device in compliance with the installation rules.

Warning

The safety wire (green-yellow) is connected to the appliance's  terminal and must be connected to the earth terminal of the electrical set-up.

The fuse in your set-up must be 16 amperes.

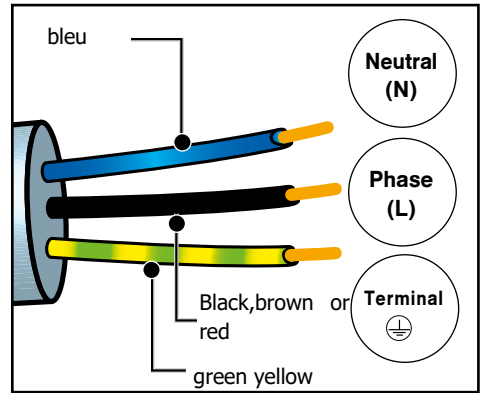

We cannot be held responsible for any accident resulting from inexistent, defective or incorrect earthing.

• **Prior to first use**

Before using your oven for the first time, heat it with the door closed for about 15 minutes on the highest temperature. to break in the appliance. The mineral wool surrounding the oven cavity may initially give off a particular odour due to its composition. You may also notice smoke development. This is normal.



Description of the oven

PRESENTATION OF THE OVEN

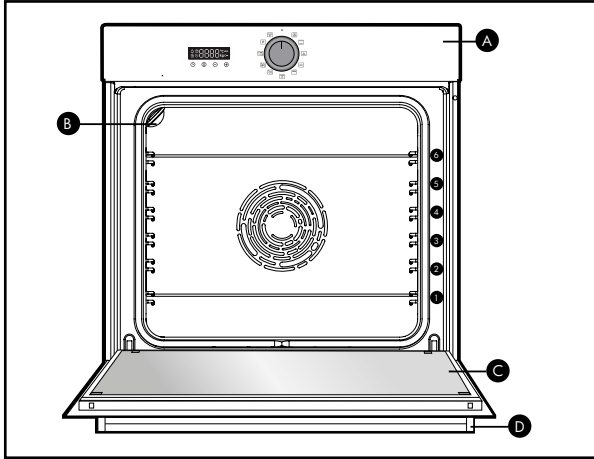

- A** Control panel
- B** Light
- C** Door
- D** Handle

This oven has 6 positions for the accessories: shelf supports 1 to 6.

DISPLAY AND BUTTONS

• Display



- Cooking time
- End of cooking
- Keypad lock
- Timer
- °C Temperature indicator
- >> Pre-heating indicator
- Door lock

• Buttons

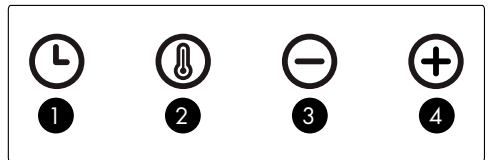

- 1** Set clock and cooking time
- 2** Set temperature
- 3** - button
- 4** + button



ACCESSORIES

• Anti-tip safety grid

The grid can be used to hold all dishes and moulds containing foodstuffs to be cooked or browned. It can be used for barbecues (to be placed directly on the grid).

Insert the anti-tip safety grid towards the back of the oven.

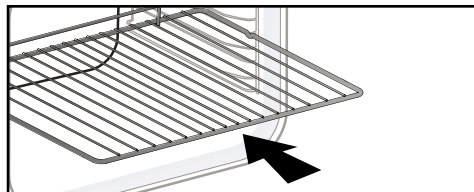

• Multi-purpose 45mm drip pan

When inserted in the supports under the grid with the handle towards the oven door, it collects juice and fat from grilling, and can be used half-filled with water as a double-boiler.



• 20mm pastry dish

When inserted in the supports with the handle towards the oven door, it is ideal for baking cookies, shortbread and cupcakes. Its tilted surface makes it practical and easy to use. Can also be inserted into the supports under the grid to collect juice and fat from grilling.

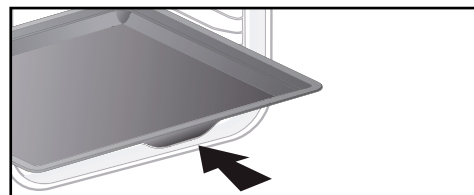

• Sliding rail system (Depending on the model)

The new sliding rail system makes food more practical and easier to handle as the trays can be effortlessly pulled for simpler handling. The trays can be completely removed, providing full access. Their stability ensures that food can be handled safely, reducing the risk of burns. This means that you can take food out of the oven far more easily.

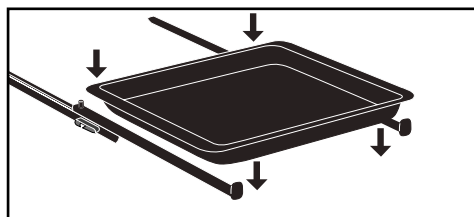

Warning :

Remove the accessories and supports from the oven before beginning pyrolysis cleaning.

Warning :

Under the effect of heat, the accessories may become deformed without affecting their function. They will return to their original shape when cooled.



INSTALLING AND REMOVING

THE SLIDING RAILS (Depending on the model)

After removing the 2 shelf runners, choose the height (2 to 5) at which you want to fit your rails. Snap the left rail against the left shelf runner by applying enough pressure to the front and back of the rail so that the 2 tabs on the side of the rail slot into the shelf runner. Do the same for the right-handrail.

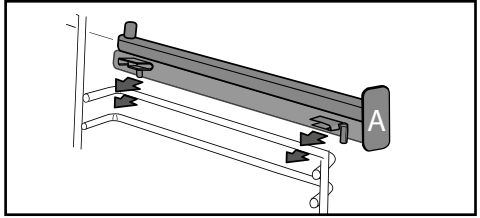

NOTE: the telescopic sliding part of the rail must unfold towards the front of the oven, with the buffer **A** opposite you.

Insert your 2 shelf runners and then put your tray on the 2 rails. The system is now ready to use.

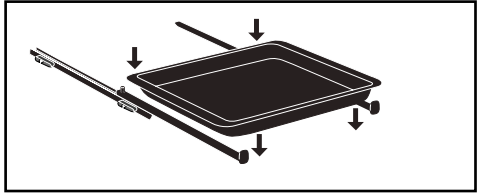

To remove the rails, remove the shelf runners again. Slightly prise apart the bottom of the tabs fixed on each rail to release

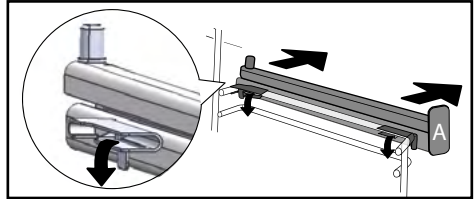

Tip

To avoid fumes when cooking fatty meats, we recommend you add a small amount of water or oil to the bottom of the drip pan.





How to use your appliance

SETTING

• Setting the clock

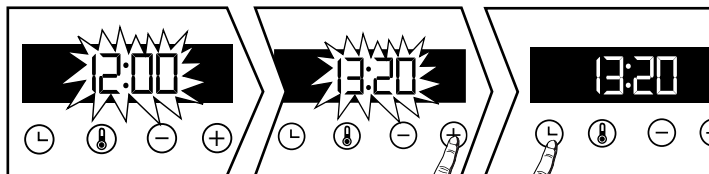
When switching on the display flashes at 12:00.





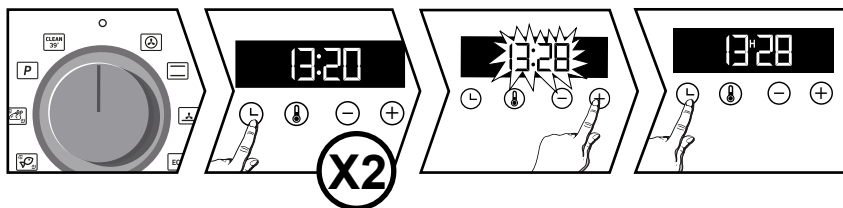

When switching on the display flashes at 12:00. Set the clock with + or -. Confirm with . If there is a power cut, the clock flashes

• Changing the clock

The function selector switch must be in the 0 position.





Press . The symbol  appears. Press  again adjust the clock setting with + or -. Confirm with . The cooking end time is automatically saved after a few seconds.

• Timer

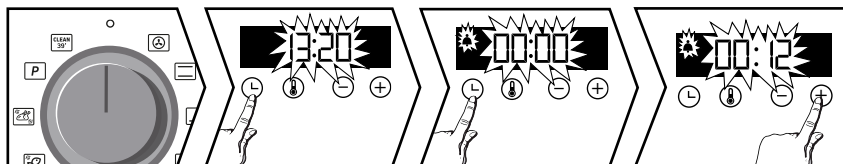
This function can only be used when the oven is switched off.



Press . The timer flashes. Set the timer with + or -. Press  to confirm. The timer will then start. Once the time has lapsed, there is a sound signal. To stop it, press any key. The time appears again in the display.



NB: You can modify or cancel the timer at any time. To cancel, go back to the timer menu and set to 00:00. Without having to confirm, the adjustment is automatically saved after a few seconds.

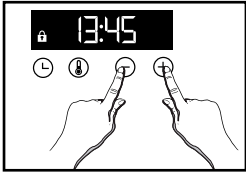

How to use your appliance

• Keypad locking





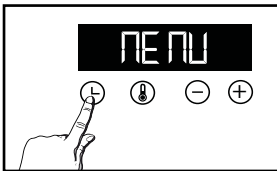

Press + and - at the same time until the  symbol appears on the screen. To unlock the keypad, press + and - together until the  symbol disappears off the screen.

SETTING

You can adjust different settings on your oven. To do so: Press  until you get to the "MENU" display to access the settings mode.



Press  again to scroll through the different settings. Activate or de-activate the different parameters with + and -; see table below:

	AUTO: In cooking mode , the light inside the oven automatically turns itself off after 90 seconds. ON: In cooking mode , the light is on all the time.
	Activate/de-activate the beeping sound of the buttons
	Activate/de-activate pre-heating mode
	Activate/de-activate demonstration mode

To exit the "MENU", press .



How to use your appliance

COOKING MODES (depending on model)

MANUAL FUNCTIONS :



CIRCULATING HEAT*

Min temperature 35°C, max 250°C

Recommended for keeping white meat, fish and vegetables moist. For cooking multiple items on up to three levels.



TRADITIONAL

Min temperature 35°C, max 275°C

Recommended for slow, gentle cooking: rich game, etc. For retaining the juices in red meat roasts. For simmering in a covered casserole, dishes that were begun on the hob (coq au vin, stew).



ECO*

Min temperature 35°C, max 275°C

This setting saves energy while maintaining the quality of the cooking.

All types of cooking are done without preheating.



FULL GRILL

Min temperature 180°C, max 275°C

Recommended for toast, gratin dishes, browning crème brûlée, etc.



GRILL PULSE

Min temperature 100°C, max 250°C

Roasts and poultry are juicy and crisp all over.

Slide the drip tray on to the bottom shelf support.

Recommended for all spit-roasted poultry or meat, for sealing and thoroughly cooking a leg or a rib of beef. To retain the moist texture of fish steaks.

AUTOMATIC FUNCTIONS :

Brandt offers you 3 new functions which automatically combine two cooking modes: traditional cooking and steam cooking in order to preserve the nutritional qualities of food and achieve faster cooking.



WHITE MEAT

Recommended for preserving the mussel and fondant of pork and veal rotisseries.



FISH

Recommended for cooking whole fish or fillets.



POULTRY

Recommended for cooking chickens, turkeys, guinea fowl and ducks.

For these 3 functions, all you need to do is introduce lukewarm water in sufficient quantity into your dish (drip pan) and place it in your oven in the bottom tier and your food to be cooked in tier 3.

For the quantity of water to be introduced into the drip pan, refer to the table of automatic combined functions with steam association at the end of the manual.



"Smart Assist"

Your oven has the "SMART ASSIST" function which, when programming a cooking time, will suggest a cooking time which can be modified depending on the selected cooking mode.

**Cooking mode as per standard EN 60350-1: 2016 to demonstrate compliance with requirements of the energy label of European regulation UE/65/2014.*



How to use your appliance

STARTING COOKING

• Immediate cooking

The programmer must only display the time. It should not be flashing. Turn the function selector to any position.

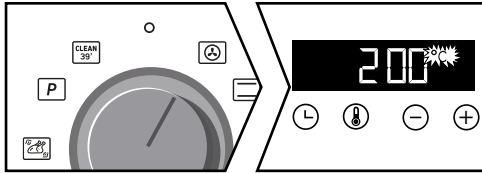



For manual functions :

The temperature rise starts immediately. Your oven recommends a modifiable temperature. The oven heats up and the temperature indicator flashes. A series of beeps will sound when the oven reaches the programmed temperature.

For automatic functions:

 appears on the screen.

Select your food using the table at the end of the manual. Press the + and - keys until you obtain the desired diagram in the display, then confirm with .

A weight flashes; enter the actual weight of your food with the + and - keys then validate with .

You have nothing else to adjust, the temperature and the cooking time are calculated automatically. The end of cooking time flashes, confirm with . Your cooking starts immediately.

• Changing the temperature

Press .

Adjust the temperature with + or -. Confirm by pressing .

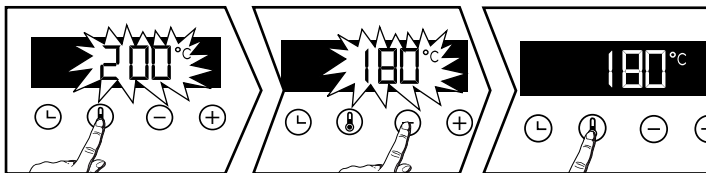

• Programming the cooking time

Use the immediate cooking programme, then press , the cooking time flashes  and it is now possible to set it. Press + and - to adjust the cooking time.

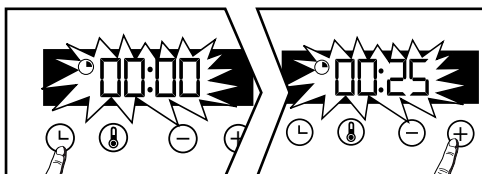



"Smart Assist"

Your oven has the "SMART ASSIST" function which, when programming a cooking time, will suggest a cooking time which can be modified depending on the selected cooking mode.

See the table opposite:

The cooking time is saved automatically after a few seconds. The time starts to count down as soon as the cooking temperature is reached.

COOKING MODE	TIME
	30 min
	30 min
	30 min
	7 min
	15 min

• Delayed start

Proceed as for programmed cooking. After setting the cooking time, press the cooking end time flashes.

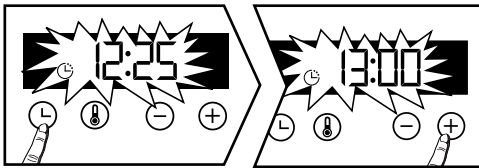

The display flashes. Set the cooking end time with + and - .

The cooking end time is automatically saved after a few seconds. The cooking end time display stops flashing.



Cleaning

CLEANING INSIDE - OUTSIDE

• Self-cleaning of the cavity by pyrolysis





Warning

Remove the accessories and wire tiers from the oven before starting a pyrolysis cleaning. Before starting a pyrolysis cleaning of your oven, remove any large overflows that may have occurred. Remove excess grease from the door with a damp sponge.

Par mesure de sécurité, l'opération de nettoyage par pyrolyse ne s'effectue qu'après blocage automatique de la porte, il est impossible de déverrouiller la porte.

• Immediate self-cleaning

Le programmeur doit afficher l'heure du jour, sans clignoter. Sélectionnez un des cycles d'autonettoyage avec la manette de fonctions  ou  :

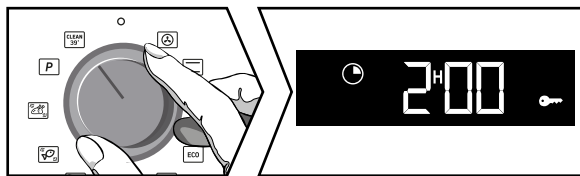





= Cleaning in 39 minutes

- At the end of each cooking cycle, "Clean 39" scrolls on the screen, suggesting that you start the cleaning process. Position the lever on this function and confirm with the key . The time 0:39 is displayed alternating with "Clean 39", your cleaning starts. After a few minutes, a key appears and the oven door is automatically locked for safety reasons during the entire programme.

If you wish to start a "Clean 39" oven that is cold or not hot enough, the program start conditions will not allow this cleaning to take place. 0:00 will appear on the display and you will have to select the other self-cleaning position.  .

= Pyrolysis of 2 hours or 1 hour and a half, as desired. Set the joystick to this function.



Set the joystick to this function.  is displayed on the screen. Press + to choose your pyrolysis according to the degree of soiling of your oven.

Depending on your choice, the duration 2:00 (or 1:30) is displayed. Confirm with the .  (or ) is displayed, the pyrolysis starts.

At the end of the cleaning process the display shows 0:00 and the door unlocks.

Reset the function selector switch to 0.

• Delayed self-cleaning

You have the possibility to postpone the departure of your Pyrolysis. When the duration of the programme is shown on the display, press the button  and set the new end time using the + and - keys, then confirm with . Self-cleaning will start later and finish at the new programmed time. Reset the function selector switch to 0 at the end of the cleaning process.



Cleaning

• Cleaning the outer surfaces

Use a window washing product applied to a soft cloth. Do not use abrasive creams or scouring sponges.

• Cleaning the shelf supports

Lift the front part of the wire shelf support upwards. Press the entire shelf support and release the front hook from its housing. Then gently pull the whole of the support towards you to release the rear hooks from their housing. Pull out the two shelf supports.

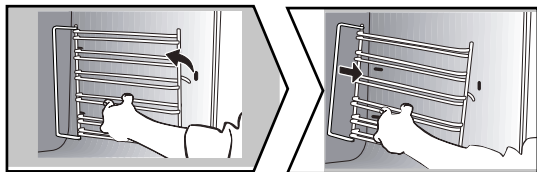

• Cleaning the inside glass



Warning

Do not use scouring cleaning products, abrasive sponges or metal scrapers to clean the oven's class door, which may scratch the surface and lead to the glass breaking.

To clean the inside glass, remove the door. Before doing this, remove any excess grease with a soft cloth and washing up liquid.

• Cleaning the inside glass

Open the door fully and block it with the plastic wedge provided in your appliance's plastic pouch.

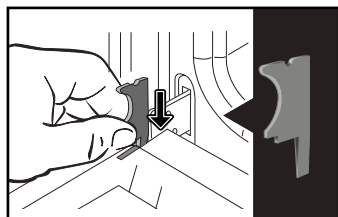

Use a tool (screwdriver) to press the slots **A** in order to unclip the glass panel. Remove the glass panel.



Important :

Make sure to mark the mounting direction of this first window (shiny side towards you).



Cleaning

Depending on the model, the door consists of two additional glass panels, with a black rubber spacer at each corner. If necessary, remove them to clean. Do not soak the glass panels in water. Rinse with clean water and dry off with a lint-free cloth.

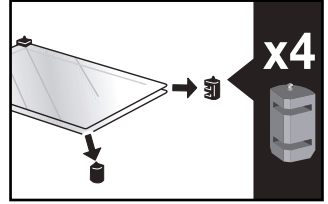
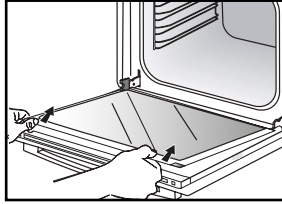
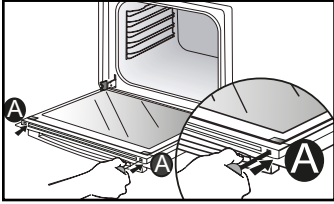

• Re-assembling the door

After cleaning, reposition the four rubber stops with the arrow upwards.

Reposition all of the glass panels.

Slip the last glass panel into the metal stops, then clip it in with the shiny side facing outwards.

Remove the plastic wedge.

Your appliance is now ready for use again.

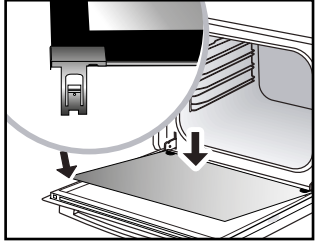
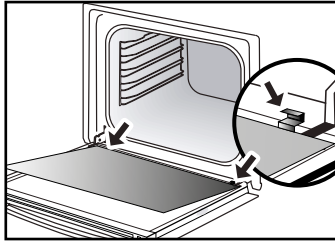
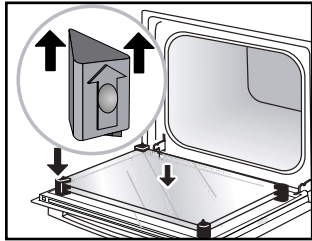

• Replacing the oven lamp



Warning:

Make sure the appliance is disconnected from the power before replacing the lamp in order to avoid the risk of electric shock. Change the lamp only when the appliance has cooled down.

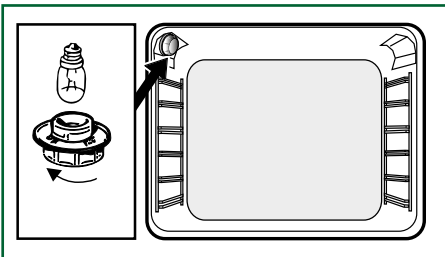

Bulb specification:

25 W, 220-240 V~, 300°C, G9 cap.

To unscrew the view port and the light, use a rubber glove, which will make disassembly easier.



ANOMALIES AND SOLUTIONS

The oven is not heating. Check that the oven is correctly connected and that your installation's fuse is not out of service. Increase the selected temperature.

The oven light is not working. Replace the bulb or the fuse. Check that the oven is correctly connected.

The cooling fan continues to operate after the oven stops. This is normal; the fan may continue running until a maximum of 1 hour after cooking to lower the temperature inside and outside the oven. If the fan runs for over an hour, contact the After Sales Department.

The pyrolysis cleaning cycle does not begin. Check that the door is locked. If there is a door locking or temperature sensor fault, contact the Customer Services Department.

The symbol  flashes in the display.

Door locking fault; contact the Customer Services Department.

Vibration noise.

Check that the power cord is not in contact with the rear wall.

This does not affect the proper operation of your unit, but may generate vibration noise during ventilation. Remove your unit and move the cord. Replace your oven.



SERVICE CALLS

Any repairs made to your appliance must be carried out by a qualified professional authorised to work on the brand. When calling, please provide the complete references of your appliance (commercial reference, service reference, serial number), so that we can handle your call better. This information appears on the manufacturer's nameplate attached to your equipment.

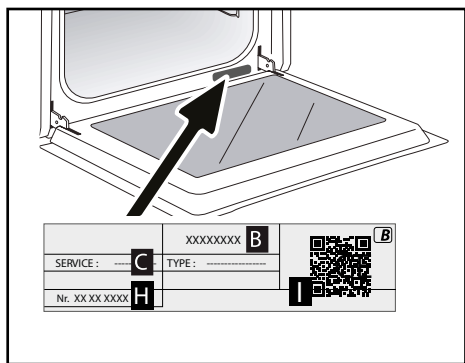

B: Commercial reference

C: Service reference









H: Serial number

I : QR Code









GENUINE REPLACEMENT PARTS

During maintenance work, request that only certified genuine replacement parts are used.



DISHES	       														min
Meat															
Roast pork (1kg)	200	2						180	2						60
Roast veal (1kg)	200	2						180	2						60-70
Roast beef	240	2													30-40
Lamb (leg, shoulder, 2.5kg)	220	1			220						200	2			60
Poultry (1kg)	200	2			220		180	2			210	3			60
Large pieces of poultry	180	1													60-90
Chicken thighs					220	3					210	3			20-30
Pork/veal chops					210	3									20-30
Beef ribs (1kg)					210	3					210	3			20-30
Lamb chops					210	3									20-30
Fish															
Grilled fish					275	4									15-20
Cooked fish (bream)	200	3					180	3							30-35
Fish in papillote	220	3					200	3							15-20
Vegetables															
Gratins (cooked foods)					275	2									30
Potato gratin	200	2					180	2							45
Lasagne	200	3					180	3							45
Stuffed tomatoes	170	3					160	2							30
Pastries															
Sponge cake			180	2									180	2	35
Swiss roll	220	3											180	2	5-10
Buns	180	1	210										180	2	35-45
Brownies	180	2					175	3							20-25
Cake - Pound cake	180	1	180	1									180	2	45-50
Clafoutis	200	2					180	3							30-35
Baked custards	165	2											150	2	30-40
Cookies - Shortbread	175	3													15-20

* Depending on the model

DISHES	       														min		
Pastries																	
Madeleines	220	3						200	3								5-10
Choux pastry	200	3						180	3						180	3	30-40
Flaky pastry hors d'oeuvres	220	3						200	3								5-10
Savarin cake	180	3													175	3	30-35
Shortcrust tart	200	1						195	1								30-40
Thin flaky crust tart	215	1						200	1								20-25
Tart made with yeast-based pastry	210	1						200	1								10-30
Other																	
Skewers	220	3				210	4										10-15
Terrine pâté	200	2						190	2								80-100
Shortcrust pizza	200	2															30-40
Dough-based pizza																	15-18
Quiches																	35-40
Soufflé														180	2		50
Pies	200	2															40-45
Bread	220							200	220								30-40

* Depending on the model



All T°C and cooking times are given for pre-heated ovens.

N.B: Before being placed in the oven , all meat must remain at least 1 hour at room temperature.

RELATIONSHIP OF SETTINGS TO TEMPERATURE T °F / °C									
Setting	1	2	3	4	5	6	7	8	9 maxi
° Fahrenheit	85	140	195	250	300	355	410	465	525

Recipe with yeast (depending on model)

Ingredients:

● Flour 2 kg ● Water 1240 ml ● Salt 40 g ● 4 packets of dehydrated baker's yeast



Mix the dough in a mixer and allow to rise in the oven.

Method: For yeast-based pastry recipes. Pour the dough into a heat-resistant dish. Remove the wire shelf supports and put the dish on the bottom.

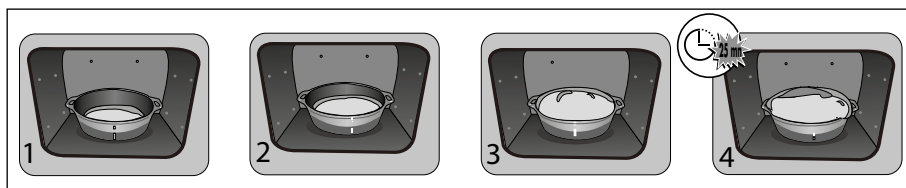
Pre-heat the oven to 40–50°C with the circulating heat function for five minutes. Stop the oven and allow the dough to rise for 25-30 minutes thanks to the residual heat.















PERFORMANCE TESTING ACCORDING TO STANDARD CEI 60350

FOOD	* Cooking modes	SHELF	ACCESSORIES	°C	TIME min.	PREHEAT
Shortbread (8.4.1)		5	Deep Tray 45mn	150	30-40	yes
Shortbread (8.4.1)		5	Deep Tray 45mn	150	25-35	yes
Shortbread (8.4.1)		2 + 5	Deep Tray 45mn + grill	150	25-45	yes
Shortbread (8.4.1)		3	Deep Tray 45mn	175	25-35	yes
Shortbread (8.4.1)		s	Deep Tray 45mn + grill	160	30-40	yes
Small cakes (8.4.2)		5	Deep Tray 45mn	170	25-35	yes
Small cakes (8.4.2)		5	Deep Tray 45mn	170	25-35	yes
Small cakes (8.4.2)		2 + 5	Deep Tray 45mn + grill	170	20-40	yes
Small cakes (8.4.2)		3	Deep Tray 45mn	170	25-35	yes
Small cakes (8.4.2)		2 + 5	Deep Tray 45mn + grill	170	25-35	yes
Fatless sponge cake (8.5.1)		4	Grill	150	30-40	yes
Fatless sponge cake (8.5.1)		4	Grill	150	30-40	yes
Fatless sponge cake (8.5.1)		2 + 5	Deep Tray 45mn + grill	150	30-40	yes
Fatless sponge cake (8.5.1)		3	Grill	150	30-40	yes
Fatless sponge cake (8.5.1)		2 + 5	Deep Tray 45mn + grill	150	30-40	yes
Apple pie (8.5.2)		1	Grill	170	90-120	yes
Apple pie (8.5.2)		1	Grill	170	90-120	yes
Apple pie (8.5.2)		3	Grill	180	90-120	yes
Surface browning (9.2.2)		5	Grill	275	3-6	yes

*Depending on the model

N.B. : To cook on 2 levels, dishes can be taken out at different times.

TABLE OF COMBINED FUNCTIONS AUTOMATIC WITH VAPOR ASSOCIATION

Position of	Display in programmer	Food	Amount of water to add
		Chicken	500 ml lukewarm water in the multipurpose tray
		Duck	500 ml lukewarm water in the multipurpose tray
		Turkey	500 ml lukewarm water in the multipurpose tray
		Pintade	800 ml lukewarm water in the multipurpose tray
		Whole fish (large)	500 ml lukewarm water in the multipurpose tray
		Whole fish (flat)	300 ml lukewarm water in the multipurpose tray
		Small whole fish	300 ml lukewarm water in the multipurpose tray
		Fish fillets	300 ml lukewarm water in the multipurpose tray
		Roast pork	500 ml lukewarm water in the multipurpose tray
		Roast veal	500 ml lukewarm water in the multipurpose tray

IMPORTANT

Insert the multipurpose tray (with lukewarm water) in the lower shelf, level 1 and your food to be cooked in the shelf level 3.

Brandt



GUÍA DE UTILIZACIÓN ES

HORNO

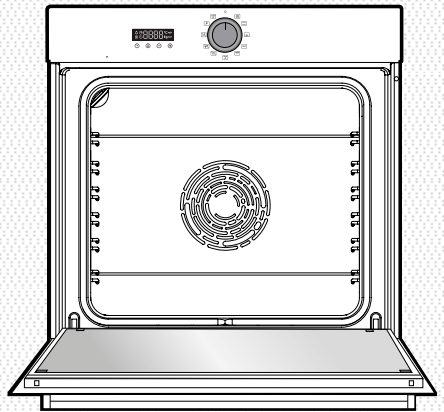

CZ2100017

ORIGINE
FRANCE[®]
GARANTIE

BYCert-6011825

Estimado/a cliente/a,

Le agradecemos la confianza que ha depositado en nosotros al adquirir este producto **BRANDT**.

Hemos diseñado y fabricado este producto pensando en usted, en su modo de vida y en sus necesidades para poder satisfacer mejor sus expectativas. animados por el espíritu innovador y la pasión que nos caracteriza desde hace más de 60 años.

Para responder a todas sus necesidades, tenemos un servicio de atención al cliente a su disposición que atenderá todas sus preguntas y sugerencias.

También puede visitar nuestra página web **www.brandt.com** donde encontrará nuestras últimas novedades, así como información útil y complementaria.

En BRANDT nos sentimos orgullosos de acompañarle en su día a día y le deseamos que disfrute plenamente de su compra.

	<p>La etiqueta "Origine France Garantie" garantiza al consumidor la trazabilidad de un producto al proporcionar una indicación clara y objetiva de la fuente. La marca Brandt se enorgullece de colocar esta etiqueta en los productos de nuestras fábricas francesas con sede en Orleans y Vendôme.</p>
--	--

<https://brandt.com/>

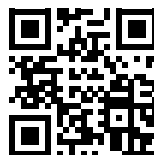

Importante:

antes de utilizar el aparato por primera vez, lea atentamente este manual para familiarizarse más rápidamente con su funcionamiento.



INSTRUCCIONES DE SEGURIDAD	4
MEDIO AMBIENTE Y AHORRO DE ENERGÍA	7
Medio ambiente	7
Consejo de Ahorro de Energía	7
INSTALANDO SU DISPOSITIVO	7
Elección de la ubicación e instalación	8
Conexión eléctrica.....	10
DESCRIPCIÓN DE SU DISPOSITIVO	11
Presentación del horno.....	11
Teclas de visualización y control.....	12
Accesorios	13
USANDO SU DISPOSITIVO	14
Ajustes	14
Menú de ajustes.....	15
Modos de cocción.....	16
Iniciar un proceso de cocción.....	17
EL CUIDADO DE SU DISPOSITIVO	19
Limpieza interior - exterior	19
ANOMALÍAS Y SOLUCIONES.....	20
SERVICIO POSTVENTA	21
Intervenciones.....	21
AYUDA DE COCINA.....	22
Cocinas.....	22
Recetas con levadura	24
Pruebas de aptitud a la función.....	25
Funciones automáticas de vapor combinado	26



INSTRUCCIONES DE SEGURIDAD IMPORTANTES - LÉALAS CON ATENCIÓN Y CONSERVELAS PARA CONSULTARLAS EN EL FUTURO.

Este manual se encuentra disponible para descarga en la página web de la marca.

Cuando reciba el aparato, desembálelo o hágalo desembalar inmediatamente. Compruebe su aspecto general. Si tiene reservas que señalar, hágalo por escrito en el albarán de entrega y quédese con un ejemplar.

Importante:

Este aparato se puede utilizar por niños de 8 años y más y por personas con capacidades físicas, sensoriales o mentales reducidas o carentes de la experiencia y del conocimiento si han podido beneficiar de una vigilancia o de instrucciones previas sobre la utilización del aparato de forma segura y han comprendido los riesgos incurridos.

— Los niños no deben jugar con el aparato. Las operaciones de limpieza y de mantenimiento no deben ser realizadas por niños sin vigilancia.

— Conviene vigilar a los niños para asegurarse de que no jueguen con el aparato.

ADVERTENCIA:

— El aparato y sus partes accesibles se calientan durante la utilización. No debe tocar los elementos calientes situados en el interior del horno.

Mantenga alejados a los niños menores de 8 años o vigílelos permanentemente.

— Este aparato ha sido diseñado para realizar cocciones con la puerta cerrada.

— Antes de proceder a la limpieza con función pirólisis del horno, retire todos los accesorios y elimine las salpicaduras importantes.

— Durante una limpieza, las superficies accesibles se calientan más que durante un uso normal.

Se recomienda alejar a los niños.

— No utilice un aparato de limpieza a vapor.

— No utilice productos de limpieza abrasivos ni estropajos metálicos duros para limpiar la puerta de cristal del horno, ya que podrían rayar la superficie y provocar la rotura del cristal.

ADVERTENCIA :

Para evitar cualquier riesgo de electrocución, asegúrese de que el aparato esté desconectado de la alimentación antes de cambiar la bombilla. Realice la intervención cuando el aparato se haya enfriado. Para desatornillar la tulipa y la bombilla, utilice un



guante de goma que facilitará el desmontaje.

El enchufe debe estar accesible después de realizar la instalación. El aparato se debe poder desconectar de la red eléctrica, bien por medio de un enchufe o bien incorporando un interruptor en las canalizaciones fijas siguiendo las normas de instalación.

— Si el cable de alimentación está dañado, debe ser reemplazado por el fabricante, su servicio de postventa o una persona de calificación similar para evitar un peligro.

— Este aparato puede instalarse indiferentemente bajo un plano o en una columna tal como se indica en el esquema de instalación.

— Centre el horno en el mueble respetando una distancia mínima de 5 mm con el mueble contiguo. El material del mueble de empotramiento debe ser resistente al calor (o estar recubierto con un material resistente). Para más estabilidad, fije el horno en el mueble con 2 tornillos, a través de los orificios previstos para dicho fin en los montantes laterales.

— El aparato no debe instalarse detrás de una puerta decorativa, con el fin de evitar un recalentamiento.

— Este aparato está destinado

para ser utilizado en aplicaciones domésticas y análogas como: Pequeñas cocinas reservadas al personal de tiendas, oficinas y entornos profesionales.

Granjas. La utilización por clientes de hoteles, moteles y otros entornos de carácter residencial, entornos de tipo habitaciones de huéspedes.

— Para cualquier intervención de limpieza en la cavidad del horno, éste debe estar apagado.

No modifique las características de este aparato; hacerlo representaría un peligro para usted.

No utilice el horno como despensa o para guardar accesorios después de su utilización.



RESPECTO DEL MEDIO AMBIENTE

- Los materiales del embalaje de este aparato son reciclables. Participe en su reciclaje y ayude a proteger el medio ambiente llevándolos a los contenedores municipales previstos para ello.



- Su aparato contiene también numerosos materiales reciclables. Por ello ha sido marcado con este logotipo que indica que los aparatos viejos no se deben mezclar con los demás residuos.

- De este modo, el reciclaje de los aparatos que organiza el fabricante se efectuará en óptimas condiciones, de acuerdo con la Directiva Europea 2002/96/CE sobre los residuos de equipos eléctricos y electrónicos.

- Pregunte en su ayuntamiento o al vendedor para conocer los puntos de recogida de aparatos viejos más cercanos a su domicilio.

- Le agradecemos su colaboración con la protección del medio ambiente.

JUNTA DE AHORRO DE ENERGÍA

Durante la cocción, mantenga la puerta del horno cerrada.



ELECCIÓN DEL EMPLAZAMIENTO Y EMPOTRAMIENTO

Los esquemas determinan las cotas de un mueble en el que será posible colocar el horno. Este aparato se puede instalar indistintamente bajo una encimera (A) o en columna (B). Si el mueble está abierto, su apertura debe ser de 70 mm como máximo en su parte posterior.

Fije el horno al mueble. Para ello, retire los topes de goma y perforo un orificio de $\varnothing 2$ mm en la pared del mueble para evitar que se agriete la madera. Fije el horno con los 2 tornillos. Vuelva a colocar los topes de goma.



Consejo

Para estar seguro de que la instalación es adecuada, no dude en recurrir a un especialista en electrodomésticos.



Atención:

Si la instalación eléctrica de la habitación obliga a efectuar una modificación para poder conectar el aparato, llame a un electricista cualificado. Si el horno presenta alguna anomalía, desconecte el aparato o quite el fusible correspondiente a la línea de conexión del horno.

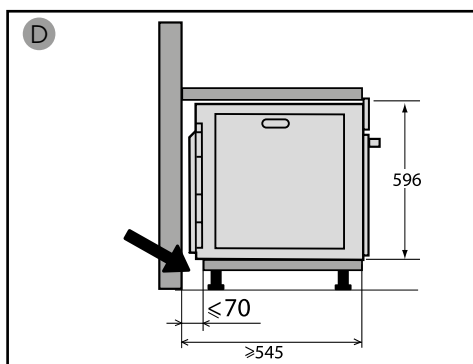
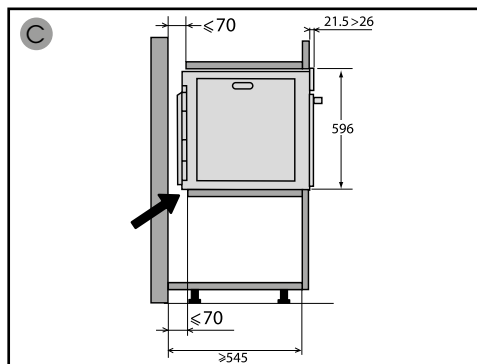
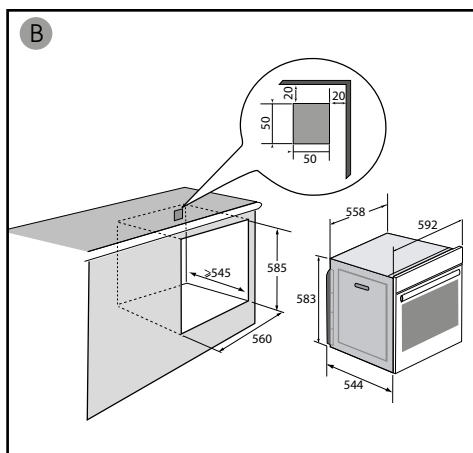
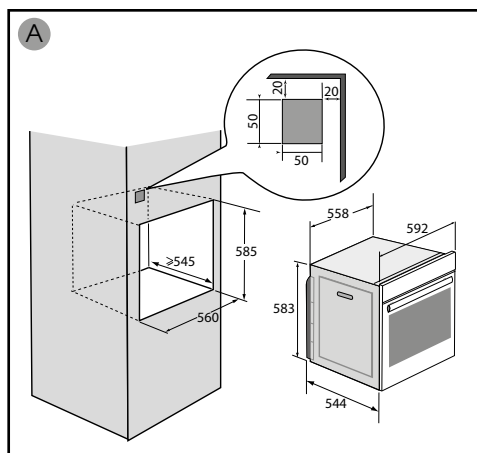



CONEXIÓN ELÉCTRICA

El horno debe estar conectado con un cable de alimentación normalizado con 3 conductores de 1,5 mm² (1 f + 1 N + tierra) conectados a la red de 220~240 voltios por medio de una toma de corriente normalizada CEI 60083 o de un dispositivo de corte omnipolar de acuerdo con las normas de instalación.



Atención:

El cable de protección (verde-amarillo) va conectado al borne  del aparato y también hay que conectarlo a la tierra de la instalación. El fusible de la instalación debe ser de 16 amperios.

No se asumirá ningún tipo de responsabilidad en caso de accidente o incidente debido a una falta de conexión de toma de tierra o a una toma de tierra defectuosa o incorrecta, ni en el caso de una conexión incorrecta.

• Antes del primer uso

Antes de usar el horno por primera vez, caliéntelo vacío con la puerta cerrada durante unos 15 minutos a la temperatura más alta. para romper el aparato. La lana mineral que rodea la cavidad del horno puede inicialmente emitir un olor particular debido a su composición. También puede notar que el humo proviene de la lana mineral. Esto es normal.

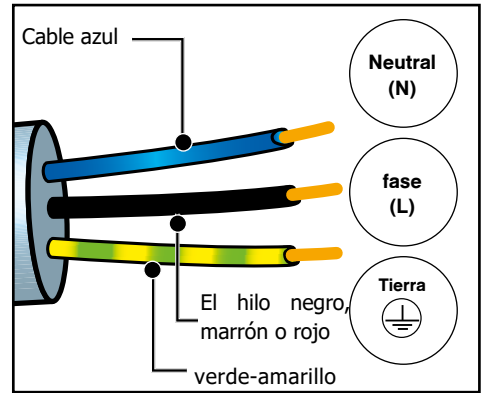



Presentación del horno

PRESENTACIÓN DEL HORNO

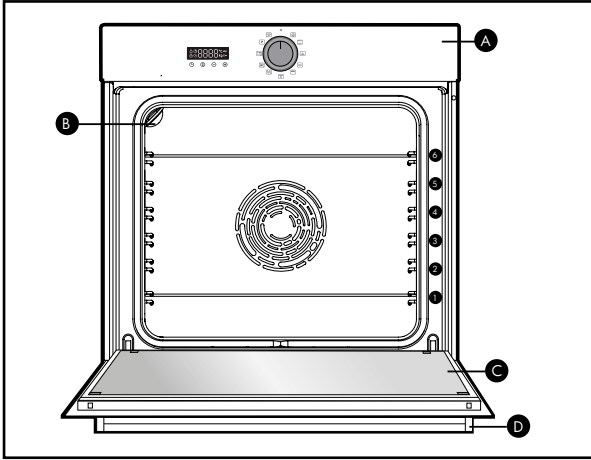

- A** Panel de mandos
- B** Lámpara
- C** Puerta
- D** Empuñadura

Este horno dispone de 6 posiciones de niveles para los accesorios: niveles 1 a 6.

TECLAS DE VISUALIZACIÓN Y CONTROL S

PANTALLA



- Tiempo de cocción
- Fin de la cocción
- Bloqueo del teclado
- Temporizador
- Indicador de temperatura
- Indicador de precalentado
- Bloqueo de la puerta

TECLAS

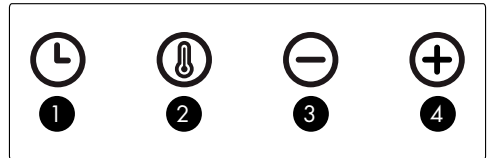

- 1** Selección de hora y tiempo
- 2** Selección de temperatura
- 3** Tecla -
- 4** Tecla +



ACCESORIOS

• Parrilla de seguridad antivuelco

La parrilla se puede utilizar como soporte para bandejas y fuentes con alimentos para asar o gratinar. También se puede utilizar para asados a la parrilla (que se colocarán directamente encima). Introduzca la parrilla de seguridad antivuelco hacia el fondo del horno.

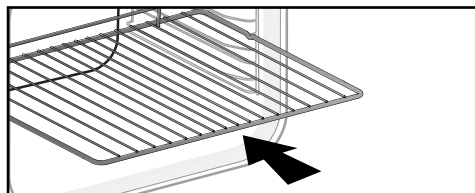

• Bandeja multiusos recogejugos de 45 mm

Se inserta en los niveles por debajo de la parrilla con la empuñadura hacia la puerta del horno. Recoge los jugos y grasas de los asados; también se puede utilizar llena de agua hasta la mitad para cocciones al baño maría.

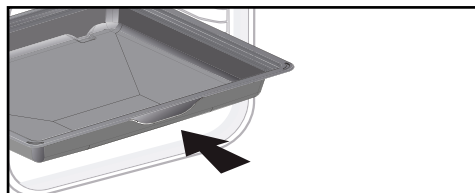

• Plato de pastelería 20mm

Para insertar en los niveles, empuñadura frente a usted. Ideal para hornear galletas, galletas de mantequilla, magdalenas. Su inclinación le permite colocar fácilmente sus preparaciones en un plato. Colocada en los alojamientos bajo la parrilla, recoge el jugo y la grasa de los asados

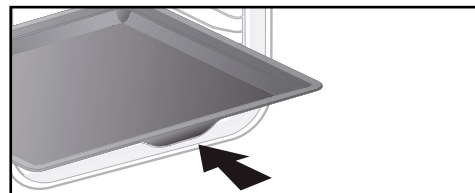

• Sistema de guías telescópicas (según modelo)

Gracias al nuevo sistema de guías telescópicas, la manipulación de los alimentos resulta más práctica y fácil, ya que las bandejas se pueden extraer suavemente, simplificando al máximo manipulación. Las bandejas son totalmente extraíbles ofreciendo una accesibilidad total.

Además, su estabilidad permite trabajar y manipular los alimentos con total seguridad, reduciendo el riesgo de sufrir quemaduras. De este modo puede retirar los alimentos del horno mucho más fácilmente.

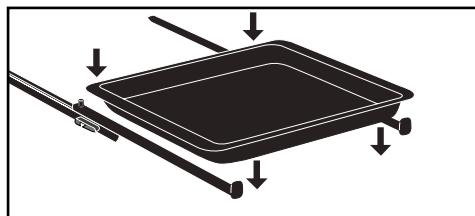

Atención:

Retire los accesorios y los niveles del horno antes de iniciar una limpieza por pirólisis.



Advertencia:

Bajo el efecto del calor, los accesorios pueden deformarse sin afectar su función. Volverán a su forma original cuando se enfríen.



INSTALACIÓN Y DESMONTAJE DE LAS GUÍAS TELESCÓPICAS (según modelo)

Tras haber retirado los 2 niveles, escoja la altura (de 2 a 5) en la que quiera fijar las guías. Encaje la guía izquierda en el nivel izquierdo efectuando una presión suficiente en la parte delantera y travesa de la guía para que las 2 patas de lateral de la guía se introduzcan en el nivel.

Proceda del mismo modo para la guía derecha.

NOTA : la parte telescópica deslizante de la guía se despliega hacia la parte delantera del horno, con el tope **A** orientado hacia usted.

Coloque los dos niveles y luego la placa sobre las 2 guías ; el sistema está listo para utilizarse.

Para desmontar las guías, retire de nuevo los niveles.

Incline ligeramente hacia abajo las patas fijadas a cada guía para liberarlas del nivel. Tire de la guía hacia usted.

Para desmontar las guías, retire de nuevo los niveles.

Incline ligeramente hacia abajo las patas fijadas a cada guía para liberarlas del nivel. Tire de la guía hacia usted.

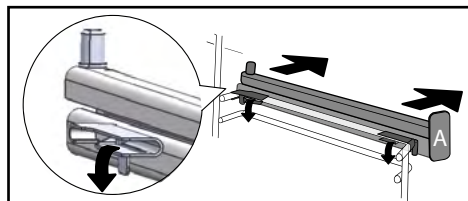
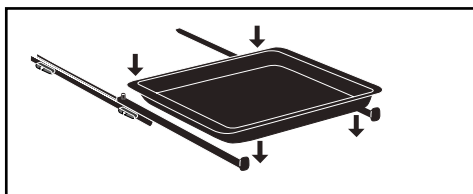
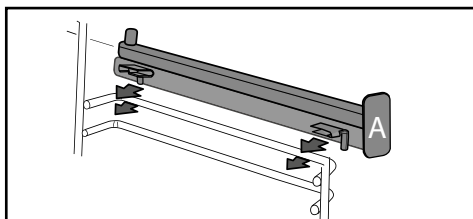

Consejo

Con el fin de evitar emisiones de humo durante la cocción de carnes grasas, le recomendamos añadir una pequeña cantidad de agua o de aceite en el fondo de la bandeja recogejugos.



RÉGLAGES

• Puesta en hora

Al conectar el aparato, la pantalla parpadea a las 12:00.

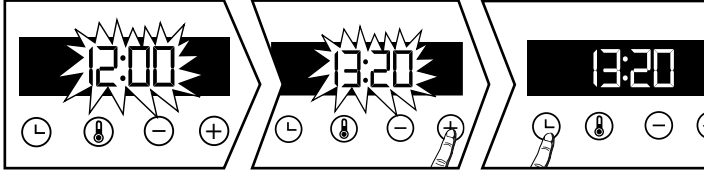



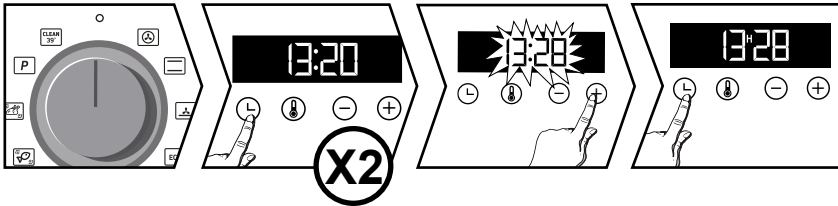

Establezca la hora con las teclas + o -. Confírmela con la tecla . En caso de un corte de corriente, la visualización de la hora parpadeará para indicarle la hora del corte.

• Cambio de la hora

El selector de función debe estar obligatoriamente en la posición 0.



Pulse la tecla  y aparecerá el símbolo del temporizador . Vuelva a pulsar  y ajuste la hora con las teclas + o -.

Confírmela con la tecla . La grabación del tiempo ajustado es automática después de unos segundos.

• Temporizador

Esta función sólo puede utilizarse cuando el horno está apagado.

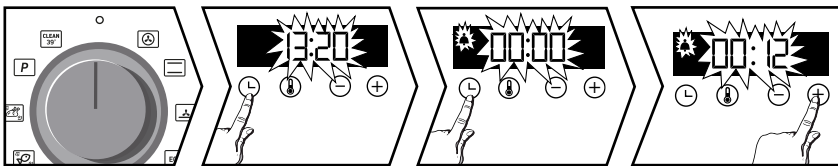

El selector de función debe estar obligatoriamente en la posición 0.



Pulse la tecla  y aparecerá el símbolo del temporizador . Ajuste la hora con las teclas + o -.

NB: Puedes cambiar o cancelar la programación del temporizador en cualquier momento. Para cancelar, vuelva al menú del temporizador y establezca las 00:00. Sin la validación, la grabación se hará automáticamente después de unos segundos.

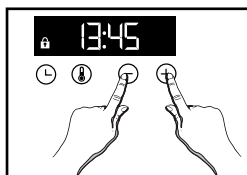

• Bloqueo del teclado



Pulse simultáneamente las teclas + y - hasta que aparezca el símbolo  Para desbloquearlo, pulse simultáneamente las teclas + y - hasta que desaparezca el símbolo  de la pantalla.

MENÚ

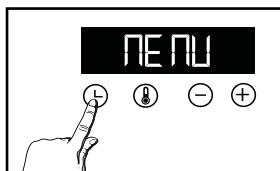

Puede modificar diferentes parámetros de su horno, para ello:

Pulse la tecla  hasta que aparezca "MENÚ" para acceder al modo de ajustes.



Vuelva a pulsar la tecla  para desplazarse por los diferentes ajustes.

Active o desactive con las teclas + y - los diferentes parámetros. Consulte la siguiente tabla:

	AUTO: En modo de cocción la lámpara de la cavidad del horno se apaga al cabo de 90 segundos. ENCENDIDO: En modo de cocción la lámpara está siempre encendida.
	Activar/desactivar los tonos de las teclas
	Activar/desactivar el modo de demostración
	Activar/desactivar el modo de precalentado

Para salir del «MENÚ», pulse de nuevo .



MODOS DE COCCIÓN (según el modelo)

Funciones manuales:



CALOR GIRATORIO*

Temperatura mínima 35°C - máxima 250°C

Recomendado para conservar la ternura de la carne blanca, el pescado y las verduras. Para las cocciones múltiples de hasta 3 niveles.



TRADICIONAL

Temperatura mínima 35°C - máxima 275°C

Recomendado para las cocciones lentas y delicadas: caza tierna, etc. Para soasar asados de carne roja. Para cocer a fuego lento en una cacerola cerrada los platos previamente cocinados en la placa de cocción (gallo al vino, liebre, etc.).



ECO*

Temperatura mínima 35°C - máxima 275°C

Esta posición permite ahorrar energía conservando las cualidades de la cocción.

Todas las cocciones se realizan sin precalentamiento.



GRILL FUERTE

Temperatura mínima 180°C - máxima 275°C

Recomendado para tostar pan, gratinar un plato, dorar una crema catalana, etc.



GRILL CON AIRE IMPULSADO

Temperatura mínima 100°C - máxima 250°C

Aves y asados jugosos y crujientes por todos los lados.

Coloque la bandeja recogejugos en el nivel más bajo. Recomendado para todas las aves o asados hechos, para soasar y cocinar hasta el centro piernas de cordero, chuletas de buey. Para que las piezas de pescado queden jugosas y tiernas.



"Smart Assist"

Su horno está equipado con la función «SMART ASSIST» la cual le recomendará durante la programación del tiempo, un tiempo modificable en función de la cocción seleccionada.

Brandt le ofrece 3 nuevas funciones que combinan automáticamente dos modos de cocción: cocción tradicional y cocción al vapor para preservar las cualidades nutricionales de los alimentos y lograr una cocción más rápida.



CARNES BLANCAS

Recomendado para preservar el moho y el fondant de los asadores de cerdo y ternera.



PISCIS

Recomendado para cocinar pescado entero o en filetes.



AVES DE CORRAL

Recomendado para cocinar pollos, pavos, gallinas de Guinea y patos.

Para estas 3 funciones, todo lo que necesita hacer es introducir agua tibia en cantidad suficiente en su plato (bandeja multiusos) y colocarla en su horno en el nivel inferior y sus alimentos para cocinar en el nivel 3.

Para conocer la cantidad de agua que debe introducirse en la bandeja, consulte la tabla de funciones automáticas combinadas con asociación de vapor al final del manual.

**Modo de cocción efectuado siguiendo las indicaciones de la norma EN 60350-1: 2016 para demostrar el cumplimiento de las exigencias de etiquetado energético de la normativa europea UE/65/2014.*



INICIAR UN PROCESO DE COCCIÓN

• Cocción inmediata

La pantalla solo debe mostrar el tiempo fijo.

Gire el selector de funciones a la posición que elija.

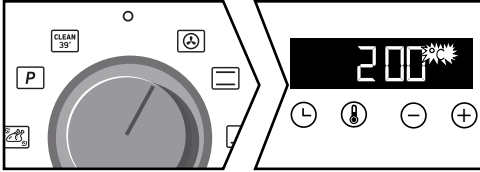



Para funciones manuales:

El aumento de temperatura comienza de inmediato. Su horno recomienda una temperatura modificable. El horno se calienta y el indicador de temperatura parpadea. Sonará una serie de pitidos cuando el horno alcance la temperatura programada.

Para funciones automáticas:

 aparece en la pantalla.

Seleccione su comida usando la tabla al final del manual. Presione las teclas + y - hasta obtener el diagrama deseado en la pantalla, luego confirme con la tecla .

Un peso parpadea; ingrese el peso real de su comida con las teclas + y - luego valide .

No tiene nada más que ajustar, la temperatura y el tiempo de cocción se calculan automáticamente. El final del tiempo de cocción parpadea, confirme con la tecla . Tu cocina comienza de inmediato.



• Modificación de la temperatura

Pulse .

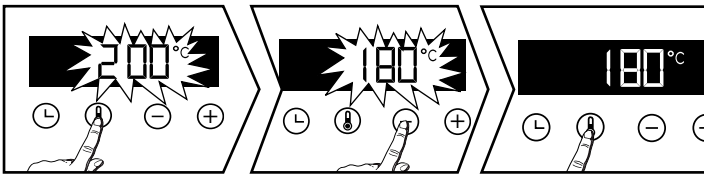
Ajuste la temperatura con + o - confírmela pulsando .



• Programación del tiempo

Efectúe una cocción inmediata y después pulse , el tiempo de cocción  parpadeará y permitirá ajustarlo. Pulse + o - para ajustar el tiempo de cocción.

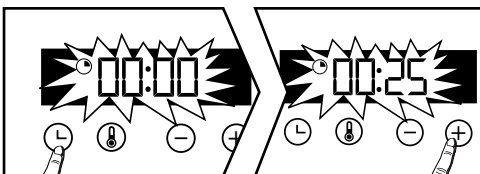



Sistema "Smart Assist"



Su horno está equipado con la función «SMART ASSIST» la cual le recomendará durante la programación del tiempo, un tiempo modificable en función de la cocción seleccionada.

Consulte la siguiente tabla:

FUNCIÓN DE COCCIÓN	RECOMENDACIÓN DE TIEMPO
	30 min
	30 min
	30 min
ECO	30 min
	7 min
	15 min

El tiempo de cocción quedará automáticamente registrado al cabo de unos segundos. La cuenta atrás se inicia inmediatamente una vez alcanzada la temperatura de cocción.

• Cocción con inicio diferido

Proceda igual que para un tiempo programado. Tras ajustar el tiempo de cocción, pulse la tecla , y parpadeará la hora de fin de cocción .

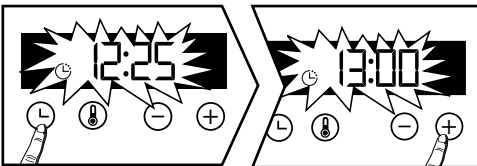

El indicador parpadeará; ajuste la hora de fin de cocción con + o -.

El final de cocción quedará automáticamente registrado al cabo de unos segundos. La pantalla de fin de cocción deja de parpadear.



LIMPIEZA DE LA SUPERFICIE EXTERIOR

• Auto-limpieza de la cavidad por pirólisis





Atención

Quita los accesorios y los cables del horno antes de empezar la limpieza por pirólisis. Antes de comenzar una limpieza de pirólisis de su horno, retire cualquier desbordamiento grande que pueda haber ocurrido. Quita el exceso de grasa de la puerta con una esponja húmeda.

Antes de proceder a una limpieza pirolítica de su horno, elimine las acumulaciones de grasa importantes que se hayan podido producir. Retire el exceso de grasa de la puerta con una esponja húmeda.

Como medida de seguridad, la operación de limpieza únicamente se efectúa tras el bloqueo automático de la puerta, y es imposible desbloquearla.

• Autolimpieza inmediata

El temporizador debe mostrar la hora del día sin parpadear. Seleccione uno de los ciclos de autolimpieza con el joystick.  o  :

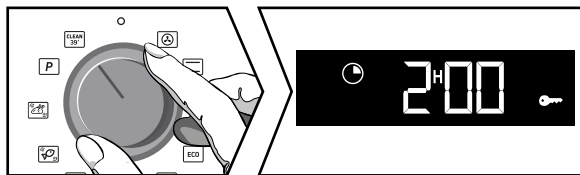





= Limpieza en 39 minutos

- Al final de cada ciclo de cocción, "Clean 39" se desplaza en la pantalla para iniciar el proceso de limpieza. Ponga la palanca en esta función y confirme con el . La hora 0:39 se muestra alternativamente con "Clean 39", su limpieza comienza. Después de unos minutos, aparece una llave y la puerta del horno se cierra automáticamente por razones de seguridad durante todo el programa.

Si desea iniciar un horno "Clean 39" que esté frío o no lo suficientemente caliente, las condiciones de inicio del programa no permitirán que se realice esta limpieza. En la pantalla aparecerá 0:00 y tendrá que seleccionar la otra posición de autolimpieza. .

= Una pirólisis de 2 horas o una hora y media, tú eliges. Ponga el joystick en esta función.



Ponga el joystick en esta función.  se muestra en la pantalla. Presiona + para elegir tu pirólisis según lo sucio que esté tu horno.

Dependiendo de su elección, la duración 2:00 (o 1:30) se muestra. Confirme con el .  (o ) se muestra, la pirólisis comienza.

Al final del proceso de limpieza, la pantalla muestra las 0:00 y la puerta se abre.

Reajuste el interruptor del selector de funciones a 0.

• Retraso en la auto-limpieza

Tiene la posibilidad de posponer la salida de su Pirólisis . Cuando la duración del programa aparezca en la pantalla, pulse la tecla  y ajustar la nueva hora final con las teclas + y - y confirmar con . La autolimpieza comenzará más tarde y terminará a la nueva hora programada. Reajuste el interruptor del selector de funciones a 0 al final de la limpieza.



• Limpieza de la superficie exterior

Utilice un paño suave empapado con limpiacristales. No utilice cremas abrasivas, ni estropajos.

• Desmontaje de los niveles

Levante la parte delantera del panel de varillas, empújelo y haga salir el gancho delantero de su alojamiento. Tire después cuidadosamente del panel de varillas hacia usted para hacer salir los ganchos posteriores de su alojamiento. Retire los dos niveles.

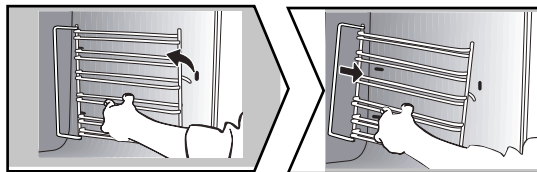

• Limpieza de los cristales interiores

Advertencia

No utilice productos de limpieza abrasivos, nanas ni raspadores metálicos para limpiar la puerta de cristal del horno, ya que se podría rayar la superficie y hacer que estallara el cristal.

Primero quita el exceso de grasa del cristal interior con un paño suave y un líquido lavavajillas. Para limpiar los vidrios interiores individuales, quítelos de la siguiente manera:

• Desmontaje de los cristales interiores

Abra la puerta por completo y bloquéela con la cuña roja de plástico incluida en la bolsa de plástico de su aparato.

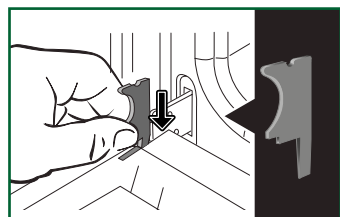

Extraiga el primer cristal enganchado:
Presione con una herramienta (destornillador) en los puntos A para desenganchar el cristal.



Importante:

Asegúrese de marcar la dirección de montaje de esta primera ventana (lado brillante hacia usted).



Limpeza

Según el modelo, la puerta se compone de dos cristales suplementarios, con un espaciador negro de goma en cada esquina. Si es necesario, retírelos para limpiarlos.

No sumerja los cristales en el agua. Aclárelos con agua limpia y séquelos con un trapo que no suelte pelusa.

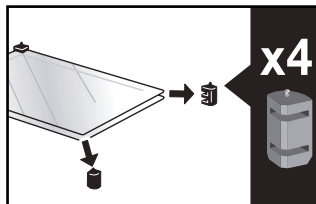
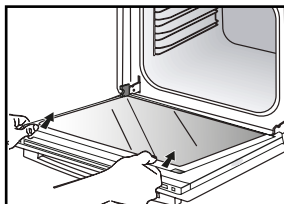
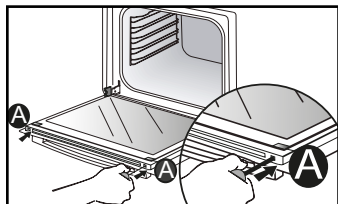

• Reinstalación de la puerta

Tras la limpieza, vuelva a colocar los cuatro topes de goma con la flecha hacia arriba y vuelva a colocar los cristales.

Introduzca el último cristal en los topes metálicos y engánchelo con la cara brillante hacia el exterior. Retire la cuña roja de plástico.

El aparato ya está nuevamente operativo.

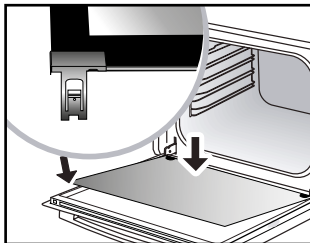
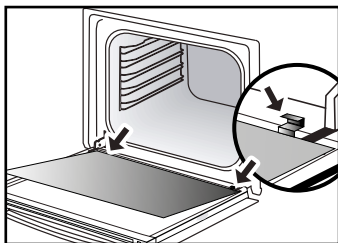
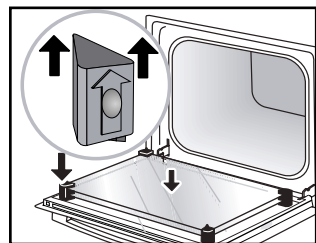

• CAMBIO DE LA LÁMPARA



Advertencia:

Para evitar cualquier riesgo de electrocución, asegúrese de que el aparato esté desconectado de la alimentación antes de cambiar la lámpara. Realice la intervención cuando el aparato se haya enfriado.

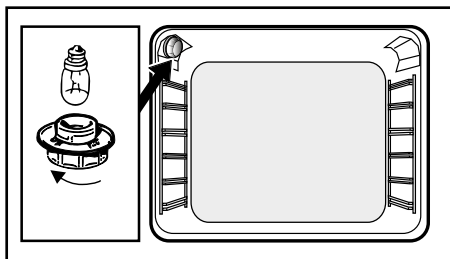

Características de la bombilla:

25 W, 220-240 V~, 300°C, casquillo G9.

Para desatornillar el plafón y la bombilla, utilice un guante de goma que facilitará el desmontaje.



Anomalías y soluciones

El horno no calienta. Compruebe que el horno esté bien enchufado y que el fusible de la instalación no esté fuera de servicio. Aumente la temperatura seleccionada.

La luz del horno no funciona. Cambie la bombilla o el fusible. Compruebe que el horno esté bien enchufado.

El ventilador de enfriamiento continúa funcionando cuando se para el horno. Es normal, la ventilación puede funcionar hasta un máximo de una hora después de la cocción para bajar la temperatura interior y exterior del horno. Si este proceso dura más de una hora, póngase en contacto con el Servicio Técnico.

La limpieza por pirólisis no se realiza. Compruebe el cierre de la puerta. Si se trata de un fallo del bloqueo de la puerta o del sensor de temperatura, llame al Servicio Técnico.

El símbolo parpadea  en la pantalla. Fallo del bloqueo de la puerta, llame al Servicio Técnico.

Ruido de vibración.

Compruebe que el cable de alimentación no esté en contacto con la pared posterior. Esto no tiene ningún impacto en el funcionamiento adecuado de su dispositivo, pero puede generar un ruido de vibración durante la ventilación. Retire su dispositivo y mueva el cable. Instale de nuevo su horno en su alojamiento.



INTERVENCIONES

Las posibles intervenciones necesarias en su aparato, deberán ser realizadas por un profesional cualificado depositario de la marca. Para facilitar el tratamiento de su solicitud, cuando llame no olvide dar las referencias completas del aparato (referencia comercial, referencia de servicio y número de serie). Esta información figura en la placa descriptiva.

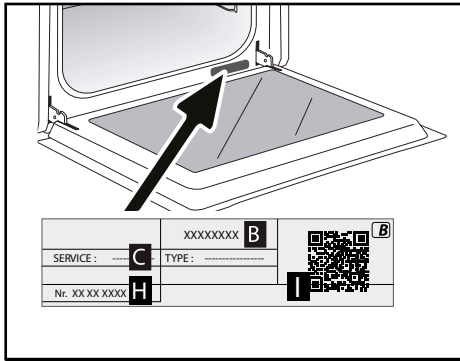









- B : Referencia comercial
- C : Referencia de servicio
- H : Número de serie
- I : QR Code

PIEZAS ORIGINALES

Si se debe realizar una intervención de mantenimiento, pida que se utilicen exclusivamente piezas de recambio certificadas originales.



PLATOS	       												min
Carne													
Asado de cerdo (1kg)	200	2					180	2					60
Asado de ternera (1kg)	200	2					180	2					60-70
Asado de buey	240	2											30-40
Cordero (pata, paletilla 2,5 kg)	220	1			220					200	2		60
Aves (1 kg)	200	2			220		180	2		210	3		60
Aves grandes piezas	180	1											60-90
Muslos de pollo					220	3				210	3		20-30
Costillas de cerdo / ternera					210	3							20-30
Costillas de buey (1kg)					210	3				210	3		20-30
Costillas de cordero					210	3							20-30
Pescados													
Pescados asados					275	4							15-20
Pescados cocinados (dorada)	200	3					180	3					30-35
Pescados en papillote	220	3					200	3					15-20
Verduras													
Gratenes (alimentos cocinados)					275	2							30
Gratenes «dauphinois»	200	2					180	2					45
Lasañas	200	3					180	3					45
Tomates rellenos	170	3					160	2					30
Pasteles													
Bizcocho esponjoso - Tarta			180	2							180	2	35
Brazo de gitano		3									180	2	5-10
Brioche	180	1	210								180	2	35-45
Brownies	180	2					175	3					20-25
Bizcocho - cuatro cuartos	180	1	180	1							180	2	45-50
Tarta de cerezas	200	2					180	3					30-35
Cremas	165	2									150	2	30-40
Galletas - Polvorones	175	3											15-20

* según modelo

PLATOS													min				
Pasteles																	
Magdalenas	220	3						200	3								5-10
Masa de buñuelos	200	3						180	3					180	3		30-40
Pastas hojaldradas	220	3						200	3								5-10
Pastel Savarin	180	3												175	3		30-35
Tarta de masa quebrada	200	1						195	1								30-40
Tarta de hojaldre fino	215	1						200	1								20-25
Tarta de masa con levadura	210	1						200	1								10-30
Varios																	
Pinchos	220	3			210	4											10-15
Paté en terrina	200	2						190	2								80-100
Pizza masa quebrada	200	2															30-40
Pizza masa de pan																	15-18
Quiches																	35-40
Suflé														180	2		50
Empanadas	200	2															40-45
Pan	220							200		220							30-40
Pan tostado	180				275	4-5											2-3
Ollas cerradas (estofados)	180	2												180	2		90-180



CALIENTE PREVIAMENTE EL HORNO ANTES DE INTRODUCIR LAS BANDEJAS

Antes de introducirla en el horno, todas las carnes deben estar al menos 1 hora a temperatura ambiente.

EQUIVALENCIA : CIFRAS °C									
°C	30	60	90	120	150	180	210	240	275
Cifras	1	2	3	4	5	6	7	8	9 maxi

Receta con levadura (según el modelo)

Ingredientes:

● 2 kg de harina ● 1.240 ml de agua ● 40 g de sal ● 4 paquetes de levadura de panadería deshidratada.







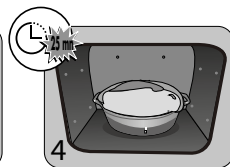











Mezcle la masa con la mezcladora y haga subir la masa en el horno.

Procedimiento: Para las recetas de masa con levadura. Vierta la masa en una fuente resistente al calor, retire los paneles de varillas y coloque la fuente en la placa.

Pre caliente el horno con la función de calor giratorio a 40-50°C durante 5 minutos. Apague el horno y deje que la masa suba durante 25-30 minutos con el calor residual.















PRUEBAS DE APTITUD A LA FUNCION SEGUN NORMA CEI 60350

ALIMENTO	* MODOS DE COCCION	NIVEL	Accesorios	°C	TIEMPO min.	PRECALENTAMIENTO
Galletas de mantequilla (8.4.1)		5	bandeja 45 mm	150	30-40	SI
Galletas de mantequilla (8.4.1)		5	bandeja 45 mm	150	25-35	SI
Galletas de mantequilla (8.4.1)		2 + 5	bandeja 45 mm + parilla	150	25-45	SI
Galletas de mantequilla (8.4.1)		3	bandeja 45 mm	175	25-35	SI
Galletas de mantequilla (8.4.1)		2 + 5	bandeja 45 mm + parilla	160	30-40	SI
Magdalenas (8.4.2)		5	bandeja 45 mm	170	25-35	SI
Magdalenas (8.4.2)		5	bandeja 45 mm	170	25-35	SI
Magdalenas (8.4.2)		2 + 5	bandeja 45 mm + parilla	170	20-40	SI
Magdalenas (8.4.2)		3	bandeja 45 mm	170	25-35	SI
Magdalenas (8.4.2)		2 + 5	bandeja 45 mm + parilla	170	25-35	SI
Bizcocho esponjoso sin grasa (8.5.1)		4	parilla	150	30-40	SI
Bizcocho esponjoso sin grasa (8.5.1)		4	parilla	150	30-40	SI
Bizcocho esponjoso sin grasa (8.5.1)		2 + 5	bandeja 45 mm + parilla	150	30-40	SI
Bizcocho esponjoso sin grasa (8.5.1)		3	parilla	150	30-40	SI
Bizcocho esponjoso sin grasa (8.5.1)		2 + 5	bandeja 45 mm + parilla	150	30-40	SI
Tarta de manzana (8.5.2)		1	parilla	170	90-120	SI
Tarta de manzana (8.5.2)		1	parilla	170	90-120	SI
Tarta de manzana (8.5.2)		3	parilla	180	90-120	SI
Superficie de gratinado (9.2.2)		5	parilla	275	3-6	SI

* según modelo

NOTA : Para cocinar sobre 2 niveles, se puede salir los platos a diferentes momentos.

TABLA DE FUNCIONES COMBINADAS AUTOMÁTICAS CON LA ASOCIACIÓN DE VAPOR

Posición de la función	Display in Programador	Alimentos	Cantidad de agua para agregar
		Pollo	500 ml de agua tibia en la bandeja multiusos
		Pato	500 ml de agua tibia en la bandeja multiusos
		Turquía	500 ml de agua tibia en la bandeja multiusos
		Pintade	800 ml de agua tibia en la bandeja multiusos
		Pescado entero (grande)	500 ml de agua tibia en la bandeja multiusos
		Pescado entero (plano)	300 ml de agua tibia en la bandeja multiusos
		Pescado entero pequeño	300 ml de agua tibia en la bandeja multiusos
		Filetes de pescado	300 ml de agua tibia en la bandeja multiusos
			500 ml de agua tibia en la bandeja multiusos
			500 ml de agua tibia en la bandeja multiusos

IMPORTANTE

Inserte la bandeja multiusos (con agua tibia) en el estante inferior, nivel 1 y sus alimentos para cocinar en el estante nivel 3.