

# Bissell®

## SPINWAVE™ CORDLESS

2240



EN	USER GUIDE
AR	مدىختس مل ا لى لى لى
BG	РЪКОВОДСТВО ЗА ПОТРЕБИТЕЛЯ
BS	KORISNIČKOM PRIRUČNIKU
CHS	使用手册
CHT	使用指南
CZ	UŽIVATELSKÁ PŘÍRUČKA
DE	BENUTZERHANDBUCH
DK	BRUGERVEJLEDNING
EL	ΟΔΗΓΟ ΧΡΗΣΗΣ
ES	GUÍA DEL USUARIO
ET	JUHENDIS
FI	KÄYTTÖOPAS
FR	MANUEL DE L'UTILISATEUR
HR	KORISNIČKI VODIČ
HE	מדריך לשימוש
HU	HASZNÁLATI ÚTMUTATÓ
IT	GUIDA PER L'UTENTE
KO	사용 설명서
LT	NAUDOTOJO VADOVE
LV	LIETOTĀJA ROKASGRĀMATĀ
MK	УПАТСТВО ЗА УПОТРЕБА
ML	PANDUAN PENGGUNA
NL	GEbruikersHANDLEIDING
NO	BRUKERVEILEDNING
PL	INSTRUKCJA OBSŁUGI
PT	MANUAL DE UTILIZAÇÃO
RO	GHID DE UTILIZARE
RU	РУКОВОДСТВО ПОЛЬЗОВАТЕЛЯ
SE	ANVÄNDARHANDBOK
SK	POUŽIVATELSKÁ PŘÍRUČKA
SL	UPORABNIŠKEM PRIROČNIKU
SR	KORISNIČKOM UPUTSTVU
TA	பயன்பாட்டு கையேடு
TH	คู่มือผู้ใช้
TR	KULLANICI KILAVUZU

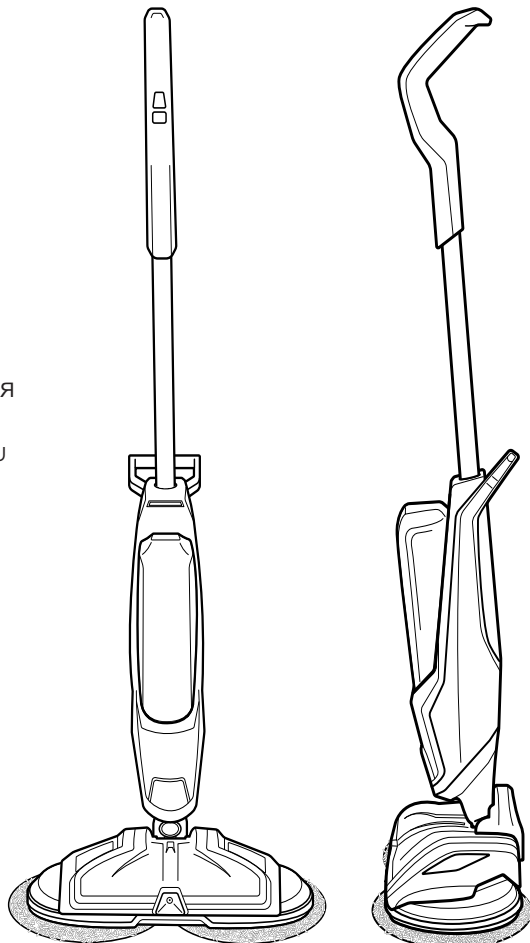



..... 3



..... 4-5



..... 6



..... 7-8

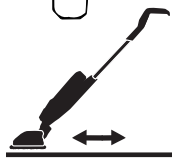

..... 9



..... 10

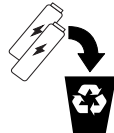

..... 11

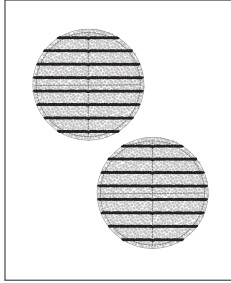
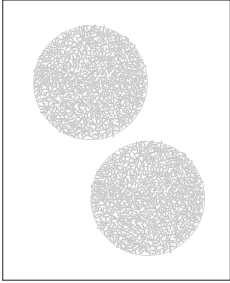
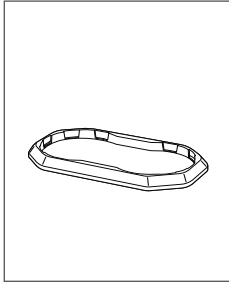
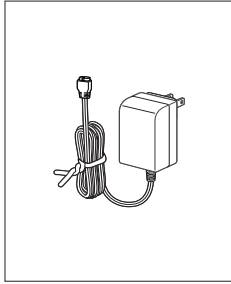
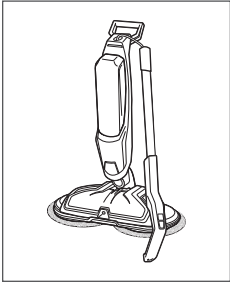

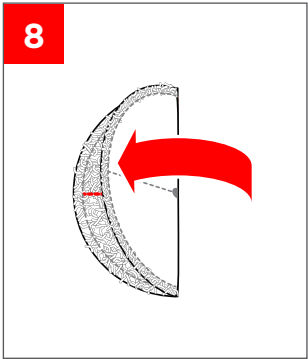
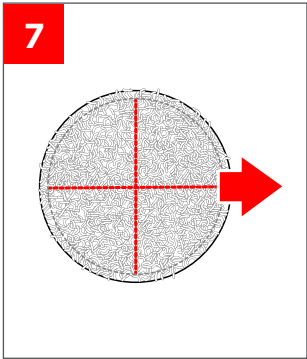
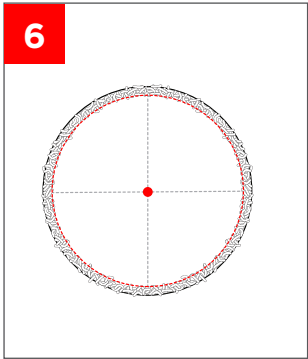
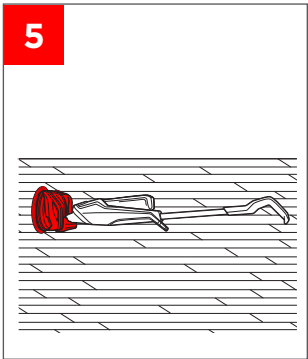
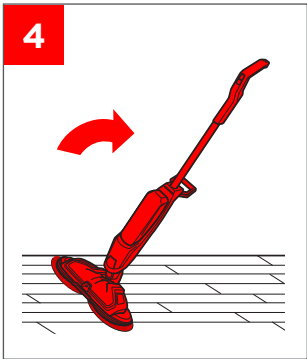
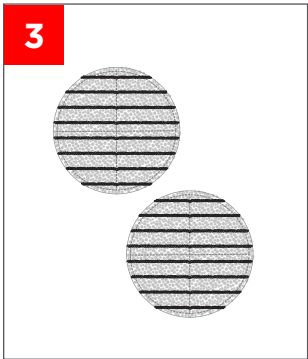
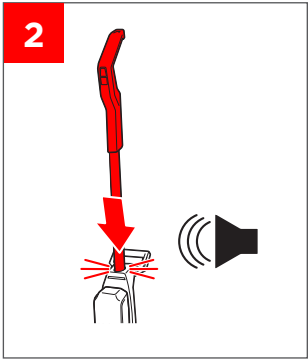
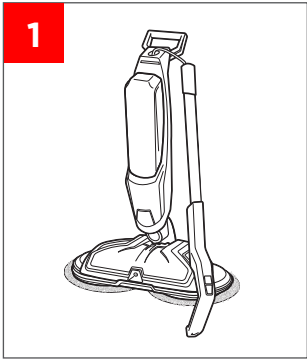
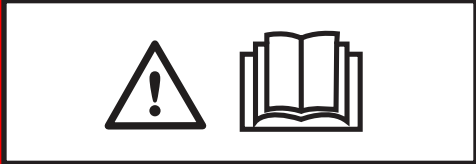

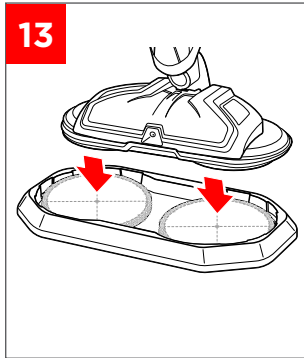
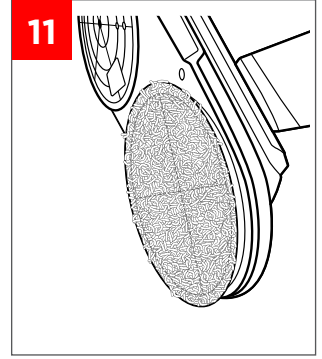
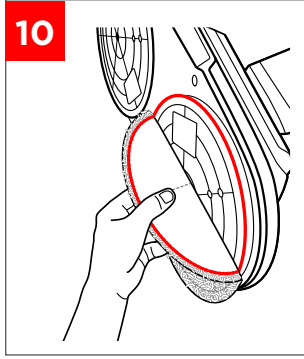
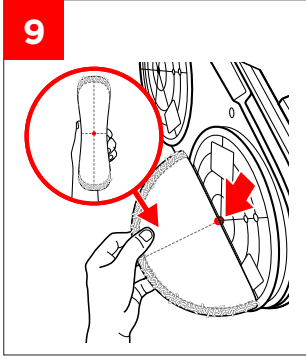

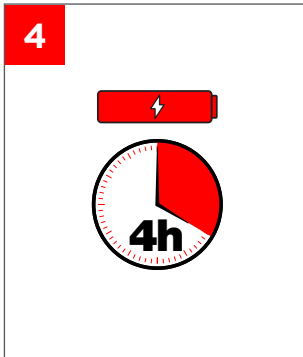
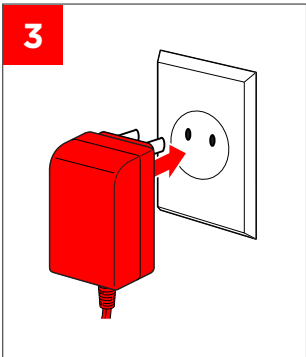
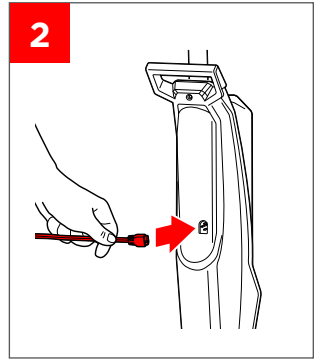
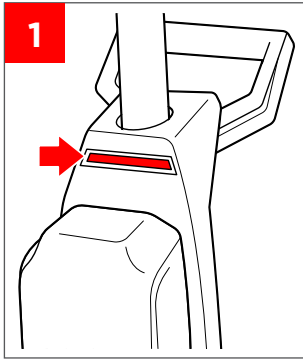

⚡ <span style="display: inline-block; width: 20px; height: 10px; background-color: red; margin-right: 5px;"></span> <span style="display: inline-block; width: 10px; height: 10px; background-color: red; margin-right: 5px;"></span> <span style="display: inline-block; width: 10px; height: 10px; background-color: red; margin-right: 5px;"></span> <input checked="" type="checkbox"/>	
BATTERY STATUS	LIGHT STATUS
100% - 67%	<span style="display: inline-block; width: 15px; height: 10px; background-color: red; margin-right: 5px;"></span> <span style="display: inline-block; width: 15px; height: 10px; background-color: red; margin-right: 5px;"></span> <span style="display: inline-block; width: 15px; height: 10px; background-color: red;"></span>
66% - 33%	<span style="display: inline-block; width: 15px; height: 10px; border: 1px solid black; margin-right: 5px;"></span> <span style="display: inline-block; width: 15px; height: 10px; background-color: red; margin-right: 5px;"></span> <span style="display: inline-block; width: 15px; height: 10px; background-color: red;"></span>
32% - 10%	<span style="display: inline-block; width: 15px; height: 10px; border: 1px solid black; margin-right: 5px;"></span> <span style="display: inline-block; width: 15px; height: 10px; border: 1px solid black; margin-right: 5px;"></span> <span style="display: inline-block; width: 15px; height: 10px; background-color: red;"></span>
> 10%	<span style="display: inline-block; width: 15px; height: 10px; border: 1px solid black; margin-right: 5px;"></span> <span style="display: inline-block; width: 15px; height: 10px; border: 1px solid black; margin-right: 5px;"></span> <span style="display: inline-block; width: 15px; height: 10px; background-color: red; border: 1px solid black; border-style: dashed;"></span>
0%	<span style="display: inline-block; width: 15px; height: 10px; border: 1px solid black; margin-right: 5px;"></span> <span style="display: inline-block; width: 15px; height: 10px; border: 1px solid black; margin-right: 5px;"></span> <span style="display: inline-block; width: 15px; height: 10px; border: 1px solid black;"></span>

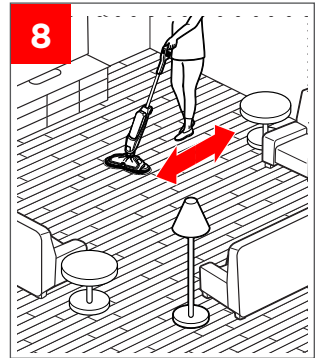
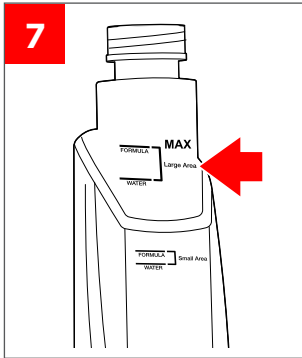
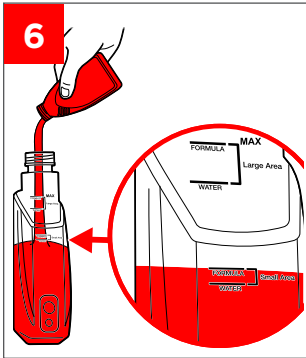
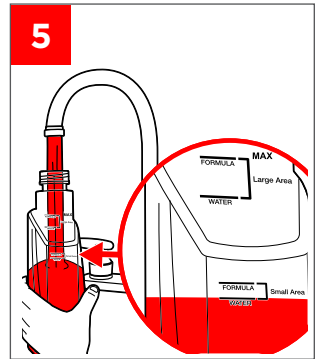
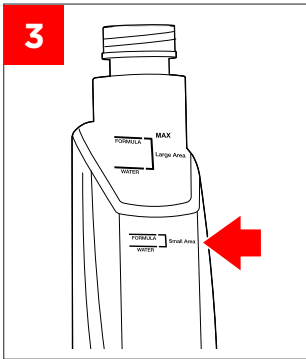
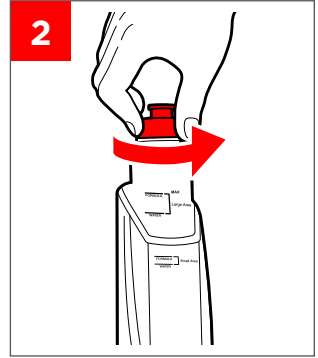
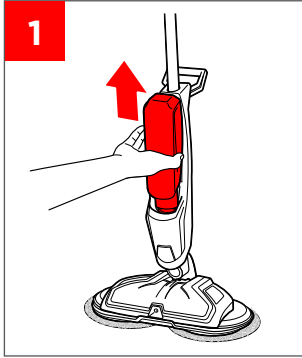

BISSELL® Multi-Surface, BISSELL Woo Floor, BISSELL Multi-Surface Pet

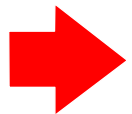

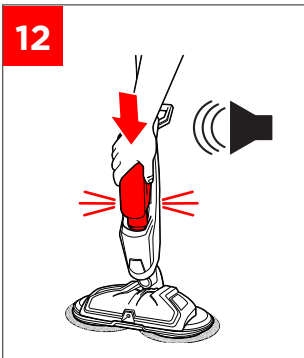
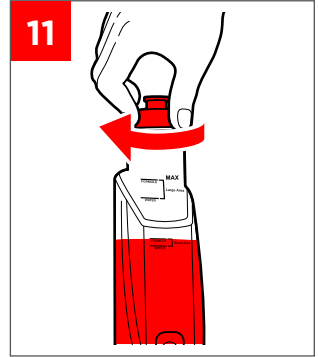
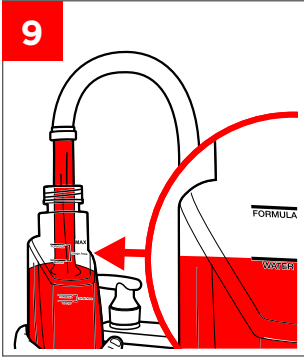

BISSELL® Multi-Surface, BISSELL Wood Floor, BISSELL Multi-Surface Pet, BISSELL Multi-Surface Pet



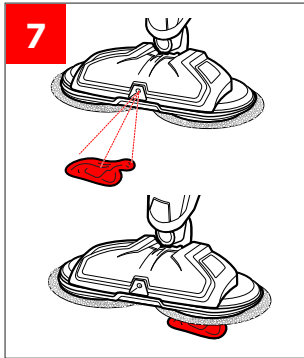
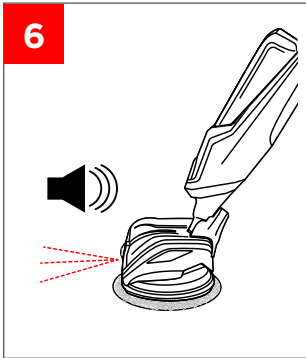
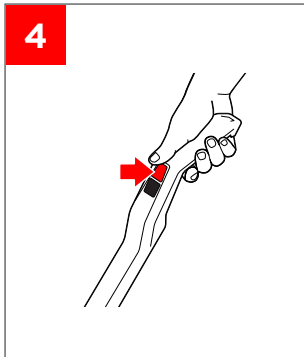
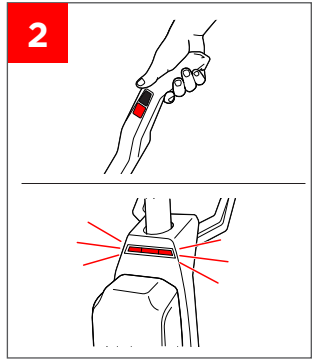
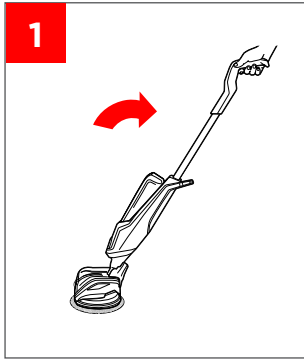
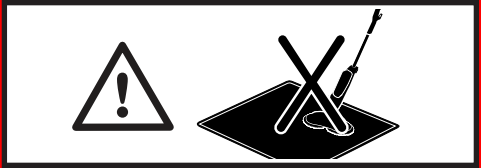
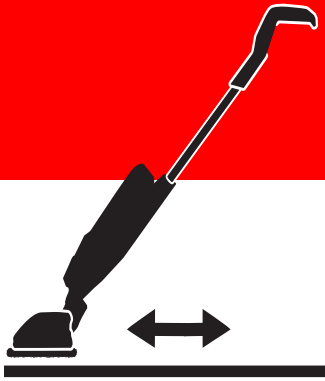

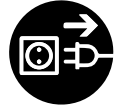
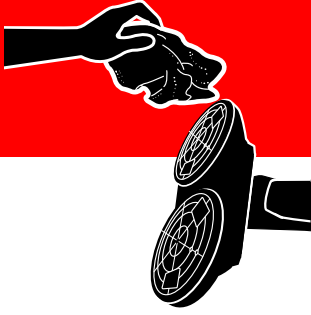

1

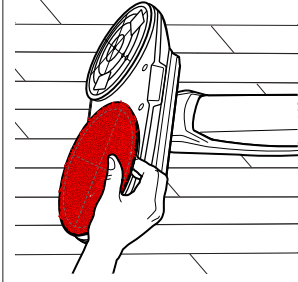

2

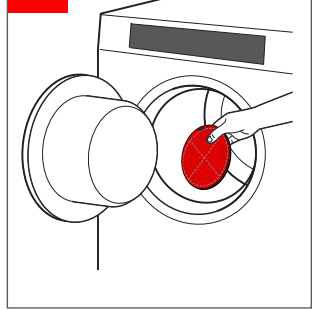

3

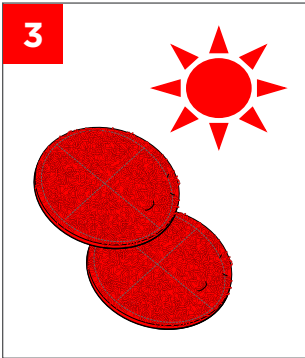

4

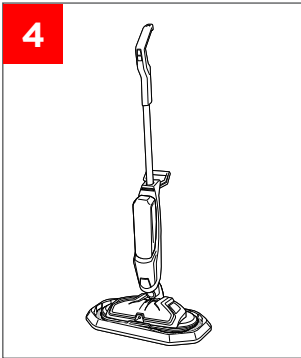





©2020 BISSELL Inc. All rights reserved.  
Part Number 1624468 06/20 RevA